

# GOODWE



## User Manual

### Grid-Tied PV Inverter

SDT G2 Series

4-25kW

V1.2-2023-02-15

**Copyright ©GoodWe Technologies Co., Ltd., 2023. All rights reserved**

No part of this manual can be reproduced or transmitted to the public platform in any form or by any means without the prior written authorization of GoodWe Technologies Co., Ltd.

**Trademarks**

**GOODWE** and other GOODWE trademarks are trademarks of GoodWe Technologies Co., Ltd. All other trademarks or registered trademarks mentioned in this manual are owned by GoodWe Technologies Co., Ltd.

**Notice**

The information in this user manual is subject to change due to product updates or other reasons. This guide cannot replace the product labels or the safety precautions in the user manual unless otherwise specified. All descriptions in the manual are for guidance only.

# CONTENTS

<b>1</b>	<b>About This Manual</b>	<b>1</b>
1.1	Applicable Model	1
1.2	Target Audience	1
1.3	Symbol Definition	2
1.4	Updates	2
<b>2</b>	<b>Safety Precaution</b>	<b>3</b>
2.1	General Safety	3
2.2	DC Side	3
2.3	AC Side	4
2.4	Inverter Installation	4
2.5	Personal Requirements	4
<b>3</b>	<b>Product Introduction</b>	<b>5</b>
3.1	Application Scenarios	5
3.2	Supported Grid Types	5
3.4	Appearance	6
3.4.1	Parts	6
3.4.2	Dimension	9
3.4.3	Indicators	11
3.4.4	Nameplate	13
<b>4</b>	<b>Check and Storage</b>	<b>14</b>
4.1	Check Before Receiving	14
4.2	Deliverables	14
4.3	Storage	15
<b>5</b>	<b>Installation</b>	<b>16</b>
5.1	Installation Requirements	16
5.2	Inverter Installation	18
5.2.1	Moving the Inverter	18
5.2.2	Installing the Inverter	18

<b>6</b>	<b>Electrical Connection.....</b>	<b>21</b>
6.1	Safety Precautions .....	21
6.2	Connecting the PE Cable.....	21
6.3	Connecting the PV Input Cable.....	22
6.4	Connecting the AC Output Cable.....	28
6.5	Communication.....	32
6.5.1	Connecting the Communication Cable (optional).....	32
6.5.2	Installing the Communication Module (optional).....	36
<b>7</b>	<b>Equipment Commissioning .....</b>	<b>37</b>
7.1	Check Items Before Switching Power ON.....	37
7.2	Power On.....	37
<b>8</b>	<b>System Commissioning.....</b>	<b>38</b>
8.1	Indicators and Button .....	38
8.2	Setting Inverter Parameters via LCD.....	40
8.2.1	LCD Menu Introduction .....	40
8.2.2	Inverter Parameter Introduction.....	42
8.3	Setting Inverter Parameters via App.....	44
8.4	Monitoring via SEMS Portal.....	44
<b>9</b>	<b>Maintenance .....</b>	<b>45</b>
9.1	Power Off the Inverter .....	45
9.2	Removing the Inverter.....	45
9.3	Disposing of the Inverter.....	45
9.4	Troubleshooting .....	45
9.5	Routine Maintenance .....	49
<b>10</b>	<b>Technical Parameters.....</b>	<b>50</b>



# 1 About This Manual

This manual describes the product information, installation, electrical connection, commissioning, troubleshooting, and maintenance. Read through this manual before installing and operating the product. All the installers and users have to be familiar with the product features, functions, and safety precautions. This manual is subject to update without notice. For more product details and latest documents, visit <https://en.goodwe.com/>.

## 1.1 Applicable Model

This manual applies to the listed inverters below (SDT G2 for short):



Model	Nominal Output Power	Nominal Output Voltage
GW4K-DT	4KW	230/400, 3L/N/PE
GW4000-SDT-20	4KW	400, 3L/N/PE
GW5K-DT	5KW	230/400, 3L/N/PE
GW5000-SDT-20	5KW	400, 3L/N/PE
GW6K-DT	6KW	230/400, 3L/N/PE
GW6000-SDT-20	6KW	400, 3L/N/PE
GW8K-DT	8KW	400, 3L/N/PE
GW10KT-DT	10KW	
GW12KT-DT	12KW	
GW15KT-DT	15KW	
GW17KT-DT	17KW	
GW20KT-DT	20KW	
GW25KT-DT	25KW	
GW8KAU-DT	8KW	
GW10KAU-DT	10KW	
GW15KAU-DT	15KW	
GW20KAU-DT	20KW	
GW8000-SDT-20	8KW	3/N/PE, 220/380, 230/400, 240/415
GW10K-SDT-20	10KW	
GW12K-SDT-20	12KW	
GW12KLV-SDT-20	12KW	220/127, 3L/N/PE
GW15K-SDT-20	15KW	3/N/PE, 220/380, 230/400, 240/415
GW17K-SDT-20	17KW	
GW20K-SDT-20	20KW	

## 1.2 Target Audience

This manual applies to trained and knowledgeable technical professionals. The technical personnel has to be familiar with the product, local standards, and electric systems.

## 1.3 Symbol Definition

Different levels of warning messages in this manual are defined as follows:

 <b>DANGER</b>
Indicates a high-level hazard that, if not avoided, will result in death or serious injury.
 <b>WARNING</b>
Indicates a medium-level hazard that, if not avoided, could result in death or serious injury.
 <b>CAUTION</b>
Indicates a low-level hazard that, if not avoided, could result in minor or moderate injury.
<b>NOTICE</b>
Highlight and supplement the texts. Or some skills and methods to solve product-related problems to save time.

## 1.4 Updates

The latest document contains all the updates made in earlier issues.

### V1.0 2022-03-15

- First Issue

### V1.1 2022-08-15

- Update **8.2.1 LCD Menu Introduction**.

### V1.2 2023-02-15

- Update **10 Technical Parameters**.

## 2 Safety Precaution

### Notice

The inverters are designed and tested strictly complies with related safety rules. Read and follow all the safety instructions and cautions before any operations. Improper operation might cause personal injury or property damage as the inverters are electrical equipment.

### 2.1 General Safety

#### Notice

- The information in this document is subject to change due to product updates or other reasons. This manual cannot replace the product labels or the safety precaution unless otherwise specified. All descriptions here are for guidance only.
- Before installations, read through the user manual to learn about the product and the precautions.
- All installations should be performed by trained and knowledgeable technicians who are familiar with local standards and safety regulations.
- Use insulating tools and wear personal protective equipment when operating the equipment to ensure personal safety. Wear anti-static gloves, cloths, and wrist strips when touching electron devices to protect the inverter from damage.
- Strictly follow the installation, operation, and configuration instructions in this manual. The manufacturer shall not be liable for equipment damage or personal injury if you do not follow the instructions. For more warranty details, visit <https://en.goodwe.com/warranty.asp>.

### 2.2 DC Side

#### DANGER

Connect the DC cables using the delivered DC connectors and terminals. The manufacturer shall not be liable for the equipment damage if other connectors or terminals are used.

#### WARNING

- Ensure the component frames and the bracket system are securely grounded.
- Ensure the DC cables are connected tightly and securely.
- Measure the DC cable using the multimeter to avoid reverse polarity connection. Also, the voltage should be under the permissible range.
- The PV modules used with the inverter must have an IEC61730 class A rating.
- If there are more than 3 PV strings on input side, an additional fuse installation will be suggested.
- When exposed to sunlight, the PV array will generate very high voltage which can cause electrical shock hazard. Please strictly follow the instruction we provided.

### 2.3 AC Side









**WARNING**

- The voltage and frequency at the connecting point should meet the on-grid requirements.
- An additional protective device like the circuit breaker or fuse is recommended on the AC side. Specification of the protective device should be at least 1.25 times the AC output rated current.
- You are recommended to use copper cables as AC output cables. Contact the manufacturer if you want to use other cables.

### 2.4 Inverter Installation

**DANGER**

- Terminals at the bottom of the inverter cannot bear much load. Otherwise, the terminals will be damaged.
- All labels and warning marks must be clear and distinct after the installation. Do not block, alter, or damage any label.
- Warning labels on the inverter are as follows.

	High voltage hazard. Power off the inverter first before any operations.		Potential risks exist. Wear proper PPE before any operations.
	Read through the guide before any operations.		Delayed discharge. Wait until the components are totally discharged after power off.
	High-temperature hazard. Do not touch the equipment to avoid being burnt.		Do not dispose of the product as household waste. Discard the product in compliance with local laws and regulations, or send it back to the manufacturer.
	CE marking.		Grounding point. Indicates the position for connecting the PE cable.
	RCM marking.	NA	NA

### 2.5 Personal Requirements

**NOTICE**

- Personnel who install or maintain the equipment must be strictly trained, learn about safety precautions and correct operations.
- Only qualified professionals or trained personnel are allowed to install, operate, maintain, and replace the equipment or parts.

### 3 Product Introduction

#### 3.1 Application Scenarios

The SDT G2 Series inverter is a three-phase PV string grid-tied inverter. The inverter converts the DC power generated by the PV module into AC power and feeds it into the utility grid. The intended use of the inverter is as follows:

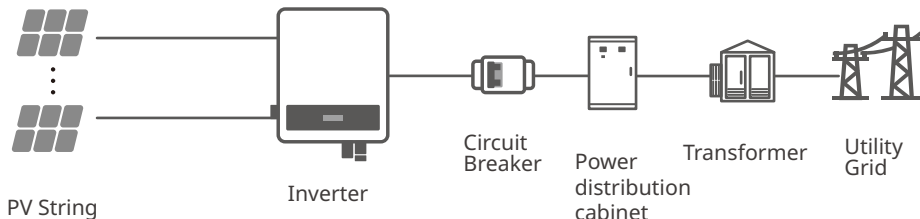

#### 3.2 Supported Grid Types

For the grid type with neutral wire, the N to ground voltage must be less than 10V.

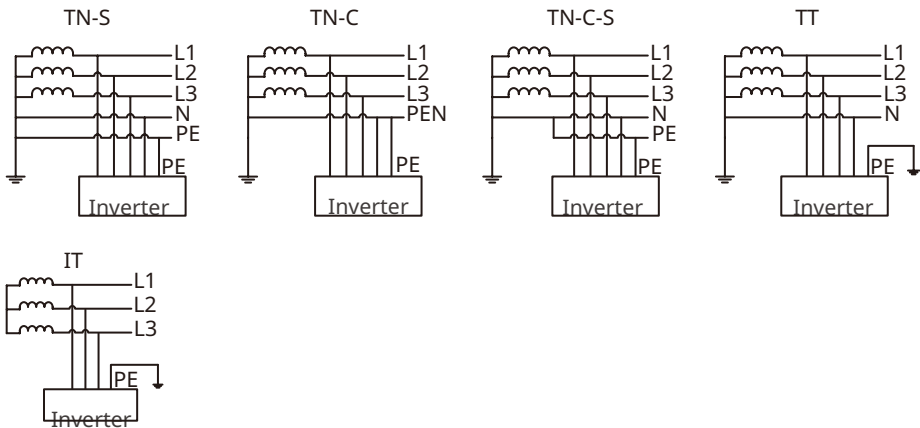

### 3.4 Appearance

#### 3.4.1 Parts

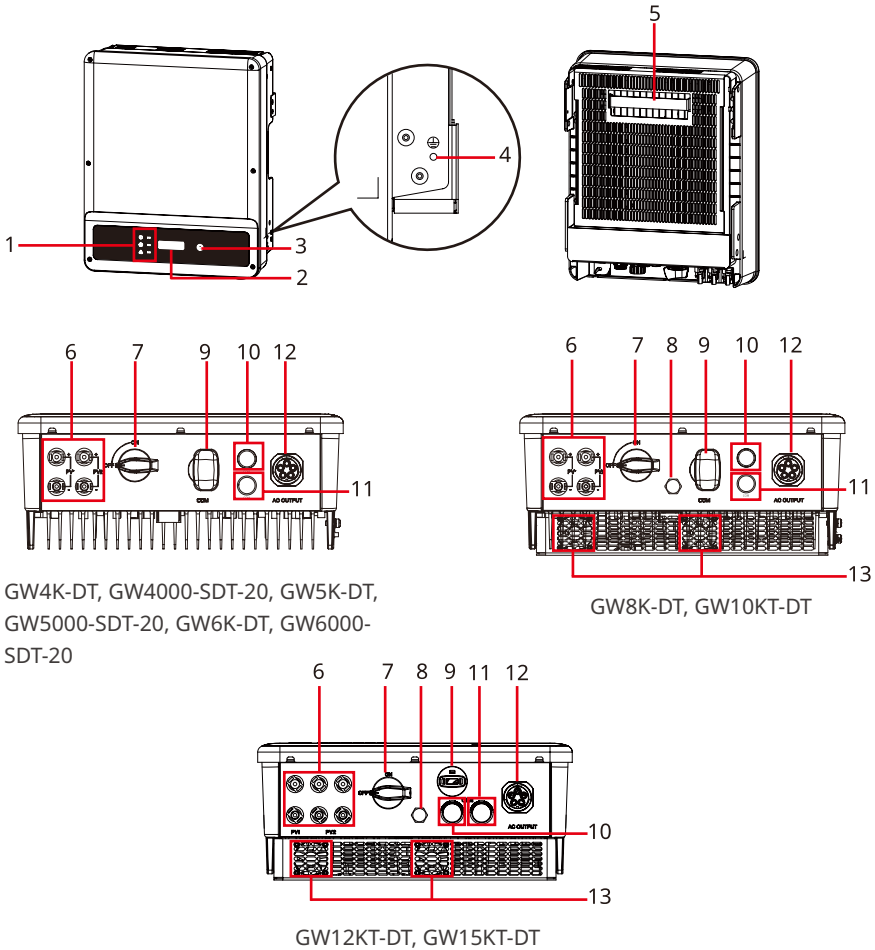

GW4K-DT, GW4000-SDT-20, GW5K-DT,  
GW5000-SDT-20, GW6K-DT, GW6000-  
SDT-20

GW8K-DT, GW10KT-DT

GW12KT-DT, GW15KT-DT

- |                                      |   |   |
|--------------------------------------|---|---|
| 1. LED Indicator                     | 2. LCD (optional)                       | 3. Button (optional)  |
| 4. PE Terminal                       | 5. Mounting Plate                       | 6. PV Input Terminal  |
| 7. DC Switch                         | 8. Ventilation valve                    | 9. Bluetooth or Wi-Fi/LAN Kit or<br>WiFi or 4G or GPRS Port |
| 10. RS485 or Smart<br>Meter COM Port | 11. DRED or Remote<br>Shutdown COM Port | 12. AC Output Port  |
| 13. Fan                              |   |   |

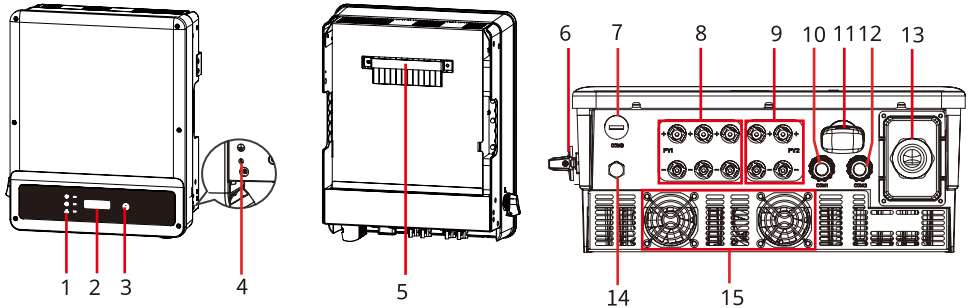

GW8KAU-DT, GW10KAU-DT, GW15KAU-DT,  
GW20KAU-DT, GW17KT-DT, GW20KT-DT,  
GW25KT-DT

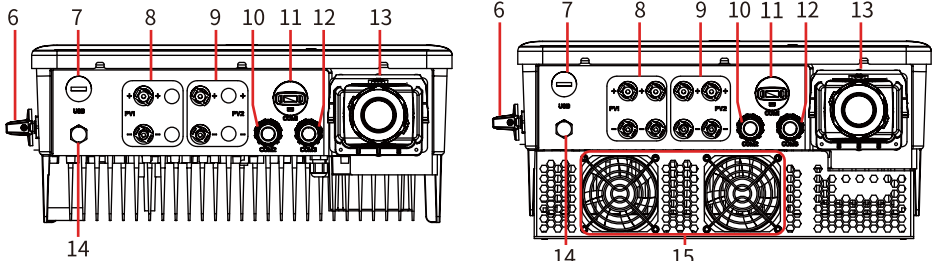

GW8000-SDT-20, GW10K-SDT-20

GW12K-SDT-20, GW12KLV-SDT-20,  
GW15K-SDT-20, GW17K-SDT-20,  
GW20K-SDT-20

- |                                      |   |                                   |
|--------------------------------------|---|-----------------------------------|
| 1. LED Indicator                     | 2. LCD (optional)   | 3. Button (optional)              |
| 4. PE Terminal                       | 5. Mounting Plate   | 6. DC Switch                      |
| 7. USB Port (For Brazil only)        | 8. PV Input Terminal (PV1) <sup>[1]</sup>                     | 9. PV Input Terminal (PV2)        |
| 10. DRED or Remote Shutdown COM Port | Bluetooth or Wi-Fi/<br>11. LAN Kit or WiFi or 4G or GPRS Port | 12. RS485 or Smart Meter COM Port |
| 13. AC Output Port                   | 14. Ventilation Valve   | 15. Fan <sup>[2]</sup>            |

[1]: GW25KT-DT: 3 x PV+/PV-; other models: 2 x PV+/PV-

[2]: Without Fan: GW8KAU-DT, GW10KAU-DT

Name	Description
PV Input Terminal	Used to connect the PV module DC input cables.
DC Switch	Start or stop DC input.
USB Port	Reserved. USB Port is used for system upgrade and configuration.
Ventilation valve	-
Communication Port	Used to connect communication modules like Bluetooth, WiFi, LAN, 4G, etc.
Smart Meter + RS485	Used to connect the Smart Meter or RS485 communication cable.
DRED(6Pin) / Remote Shutdown (2pin)	Used to connect DRED or remote shutdown communication cable. DRED for Australia and New Zealand, Remote Shutdown only for Europe.
AC Output Terminal	Used to connect AC output cable. Connect the inverter and the utility grid.
Fans	Used to cool the inverter. Without Fan: GW8KAU-DT, GW10KAU-DT.
LED Indicator	Indicates working state of the inverter
LCD	Optional. Used to check the parameters of the inverter.
Button	Optional. Used to control contents displayed on the screen.
Grounding Point	Used to connect the PE cable.
Mounting Plate	Used to install the inverter.



### 3.4.2 Dimension

Dimensions of GW4K-DT, GW4000-SDT-20, GW5K-DT, GW5000-SDT-20, GW6K-DT, GW6000-SDT-20, GW10KT-DT:

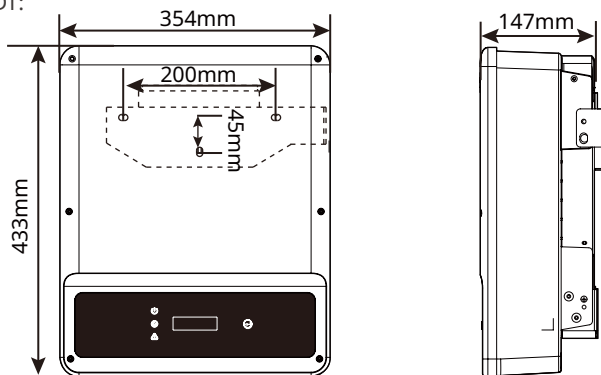

Dimensions of GW8K-DT, GW10KT-DT, GW12KT-DT, GW15KT-DT:

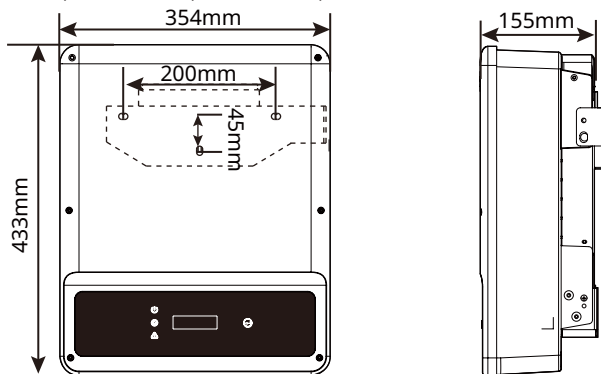

Dimensions of GW8KAU-DT, GW10KAU-DT, GW15KAU-DT, GW20KAU-DT, GW17KT-DT, GW20KT-DT, GW25KT-DT, GW25KT-DT, GW8000-SDT-20, GW10K-SDT-20:

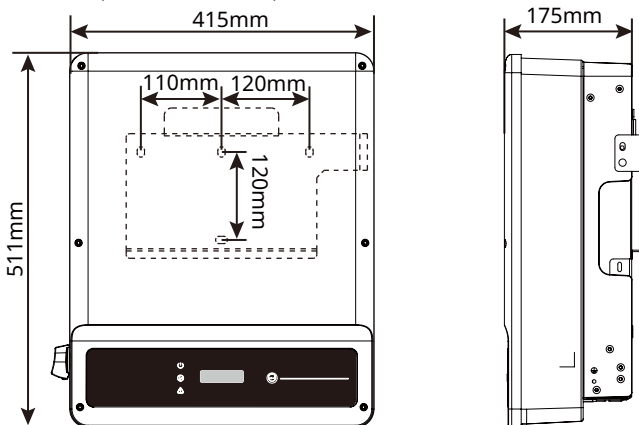

Dimensions of GW12K-SDT-20, GW12KLV-SDT-20, GW15K-SDT-20, GW17K-SDT-20, GW20K-SDT-20:

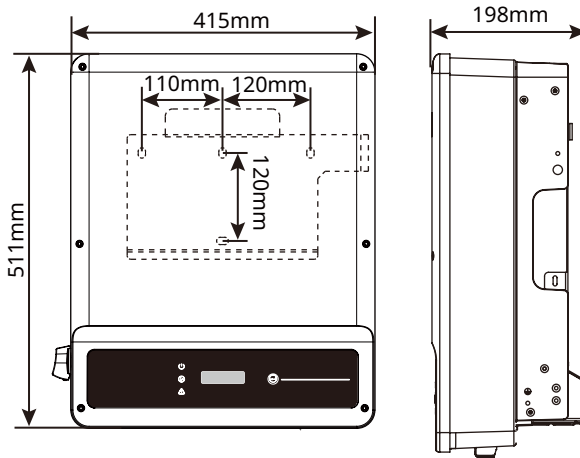











### 3.4.3 Indicators

As a human-computer interaction interface, LCD display panel comprises of LED indicators, buttons and LCD display on the front panel of the inverter. LED indicates the working status of the inverter. Buttons and LCD are used for configuration and viewing parameters.



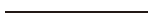

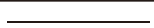



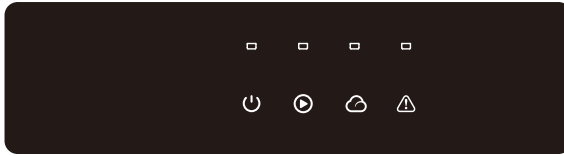









#### Inverters Designed with LCD



Indicator	Status	Description
		ON = Wi-Fi IS CONNECTED/ACTIVE
		BLINK 1 = Wi-Fi SYSTEM IS RESETTING
		BLINK 2 = NOT CONNECTED TO THE ROUTER
		BLINK 4 = Wi-Fi SERVER PROBLEM
		BLINK = RS485 IS CONNECTED
		OFF = Wi-Fi IS NOT ACTIVE
		ON = THE INVERTER IS FEEDING POWER
		OFF = THE INVERTER IS NOT FEEDING POWER AT THE MOMENT
		ON = A FAULT HAS OCCURRED
		OFF = NO FAULT

### Inverters Designed without LCD



Indicator	Status	Description
		ON = EQUIPMENT POWER ON
		OFF = EQUIPMENT POWER OFF
		ON = THE INVERTER IS FEEDING POWER
		OFF = THE INVERTER IS NOT FEEDING POWER
		SINGLE SLOW FLASH = SELF CHECK BEFORE CONNECTING TO THE GRID
		SINGLE FLASH = CONNECTING TO THE GRID
		ON = WIRELESS IS CONNECTED/ACTIVE
		BLINK 1 = WIRELESS SYSTEM IS RESETTING
		BLINK 2 = WIRELESS ROUTER PROBLEM
		BLINK 4 = WIRELESS SERVER PROBLEM
		BLINK = RS485 IS CONNECTED
		OFF = WIRELESS IS NOT ACTIVE
		ON = A FAULT HAS OCCURRED
		OFF = NO FAULT

### 3.4.4 Nameplate

The nameplate is for reference only.

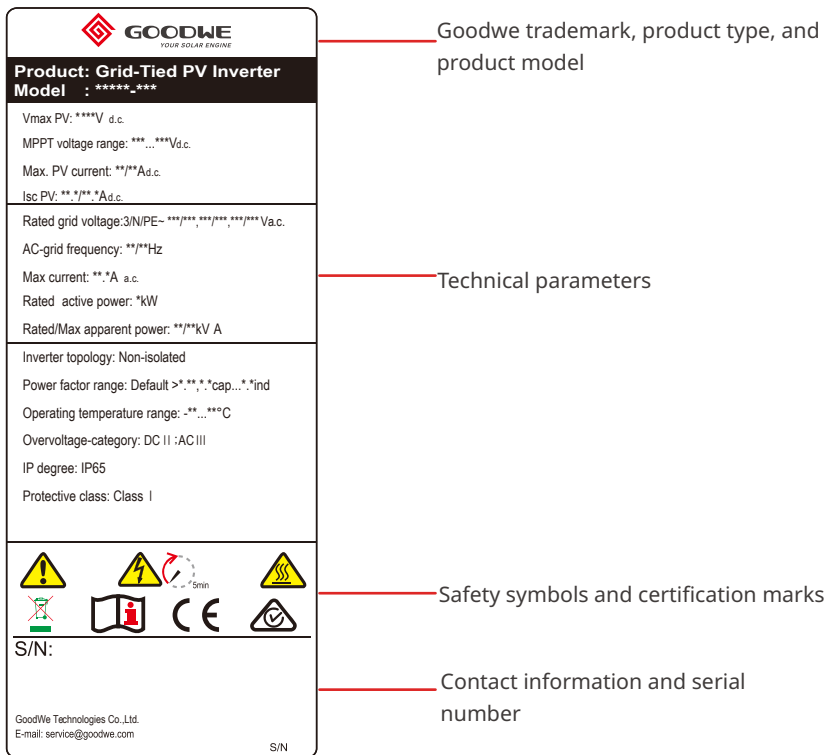









The nameplate is a rectangular label with the following sections:

- Top Section:** Goodwe logo and "GOODWE YOUR SOLAR ENGINE".
- Product/Model Section:** "Product: Grid-Tied PV Inverter" and "Model : \*\*\*\*\*".
- Technical Parameters Section:**
  - Vmax PV: \*\*\*\*V d.c.
  - MPPT voltage range: \*\*\*...\*\*\*Vd.c.
  - Max. PV current: \*\*\*\*Ad.c.
  - Isc PV: \*\*.\*A d.c.
  - Rated grid voltage: 3/N/PE~ \*\*\*\*/\*/\*/\*/\*/\*/\*/\* V a.c.
  - AC-grid frequency: \*\*/\*Hz
  - Max current: \*\*.\*A a.c.
  - Rated active power: \*kW
  - Rated/Max apparent power: \*\*/\*kV A
- Operational/Environmental Section:**
  - Inverter topology: Non-isolated
  - Power factor range: Default >\*.\*\*,\*.cap...\*.ind
  - Operating temperature range: \*\*...\*\*C
  - Overvoltage-category: DC II : AC III
  - IP degree: IP65
  - Protective class: Class I
- Safety and Certification Section:**
  - Warning symbols: High voltage, High temperature, Discharge, and others.
  - CE Mark and RCM Mark.
- Bottom Section:** "S/N:" followed by a blank space for the serial number.
- Footer:** "GoodWe Technologies Co.,Ltd. E-mail: service@goodwe.com" and "S/N" label.

Callouts from the right side of the image:

- Goodwe trademark, product type, and product model (points to the top section).
- Technical parameters (points to the technical parameters section).
- Safety symbols and certification marks (points to the safety and certification section).
- Contact information and serial number (points to the S/N field).

	High voltage hazard. Power off the inverter before any operations.		Potential risks exist. Wear proper PPE before any operations.
	Read through the user manual before any operations.		Delayed discharge. Wait until the components are discharged after power off.
	High-temperature hazard. Do not touch the equipment to avoid being hurt.		Do not dispose of the product as household waste. Discard the product in compliance with local laws and regulations, or send it back to the manufacturer.
	CE Mark.		RCM Mark.











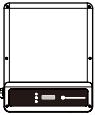
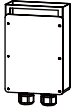
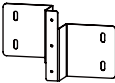



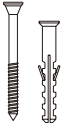

## 4 Check and Storage

### 4.1 Check Before Receiving

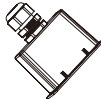
Check the following items before receiving the product.

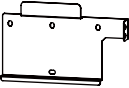
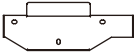
1. Check the outer packing box for damage, such as holes, cracks, deformation, and others signs of equipment damage. Do not unpack the package and contact the supplier as soon as possible if any damage is found.
2. Check the inverter model. If the inverter model is not what you requested, do not unpack the product and contact the supplier.
3. Check the deliverables for correct model, complete contents, and intact appearance. Contact the supplier as soon as possible if any damage is found.

### 4.2 Deliverables

				
Inverter X 1	PV Box X N	PV Box Bracket X N	Positive PV Connector X N	Negative PV Connector X N
				
Cross Screwdriver X N	PE OT Terminal X 1	AC PIN Terminal X N	Communication Connector X N	Screw X N
				
Expansion Bolt X N	Communication Module X N	AC Connector X N	AC Connector X N	Mounting Bracket X N
				
Mounting Bracket X N	PIN Terminal X N	AC cable OT Terminal X N	Documentation X 1	

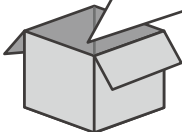

**NOTICE**

- The number of expansion bolts, screws, PV connectors, AC cable OT Terminal, and PIN terminals are various depending on the different inverters. The actual accessories may differ.
- Communication module types including WiFi, 4G, LAN, GPRS, Bluetooth, etc. The actual module delivered depends on the communication method of the selected inverter.
- The model of the AC connector and mounting bracket are various depending the different inverters. The actual accessories may differ.
- Only model GW15KAU-DT and GW20KAU-DT are equipped with PV box and PV box bracket.

### 4.3 Storage

If the equipment is not to be installed or used immediately, please ensure that the storage environment meets the following requirements:

1. Do not unpack the outer package or throw the desiccant away.
2. Store the equipment in a clean place. Make sure the temperature and humidity are appropriate and no condensation.
3. The height and direction of the stacking inverters should follow the instructions on the packing box.
4. The inverters must be stacked with caution to prevent them from falling.
5. If the inverter has been long term stored, it should be checked by professionals before being put into use.

## 5 Installation

### 5.1 Installation Requirements

#### Installation Environment Requirements

1. Do not install the equipment in a place near flammable, explosive, or corrosive materials.
2. Install the equipment on a surface that is solid enough to bear the inverter weight.
3. Install the equipment in a well-ventilated place to ensure good dissipation. Also, the installation space should be large enough for operations.
4. The equipment with a high ingress protection rating can be installed indoors or outdoors. The temperature and humidity at the installation site should be within the appropriate range.
5. Install the equipment in a sheltered place to avoid direct sunlight, rain, and snow. Build a sunshade if it is needed.
6. Do not install the equipment in a place that is easy to touch, especially within children's reach. High temperature exists when the equipment is working. Do not touch the surface to avoid burning.
7. Install the equipment at a height that is convenient for operation and maintenance, electrical connections, and checking indicators and labels.
8. Install the equipment away from electromagnetic interference.

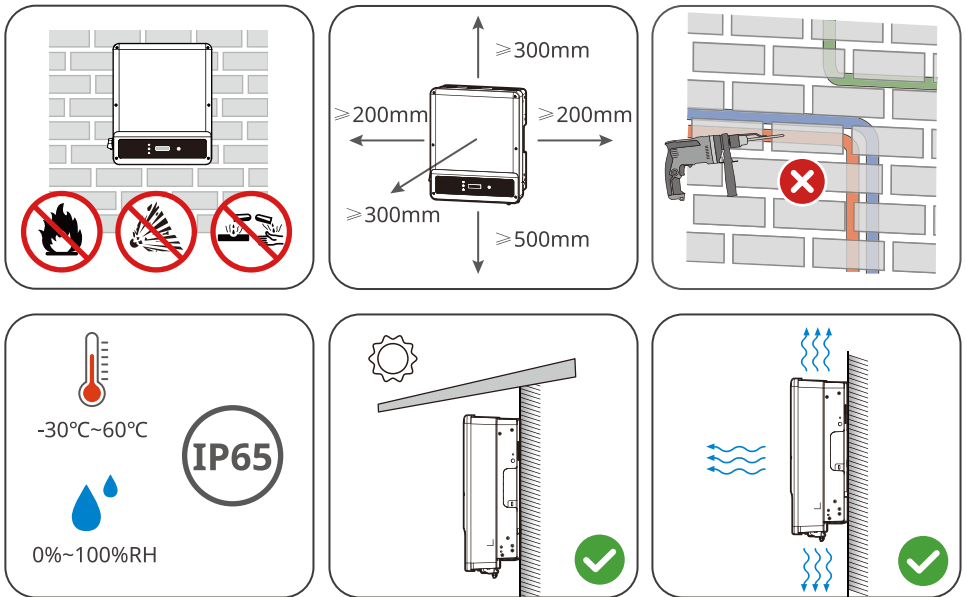

#### Mounting Support Requirements

1. The mounting support shall be nonflammable and fireproof.
2. Make sure that the support surface is solid enough to bear the product weight load.
3. Do not install the product on the support with poor sound insulation to avoid the noise generated by the working product, which may annoy the residents nearby.



### Installation Angle Requirements

- Install the inverter vertically or at a maximum back tilt of 15 degrees.
- Do not install the inverter upside down, forward tilt, back forward tilt, or horizontally.

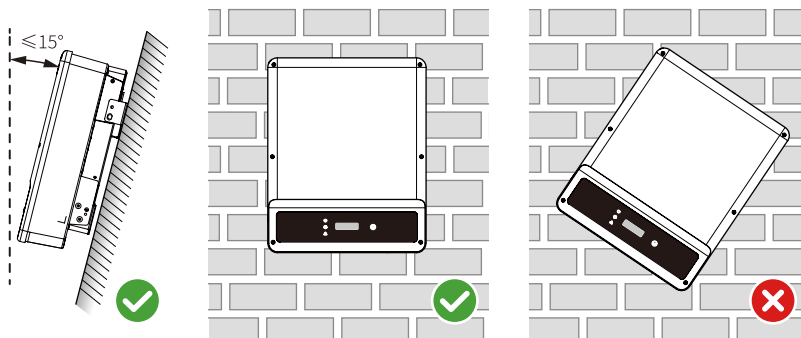

### Installation Tool Requirements

The following tools are recommended when installing the equipment. Use other auxiliary tools on site if necessary.



## 5.2 Inverter Installation

### 5.2.1 Moving the Inverter

#### CAUTION

Move the inverter to the site before installation. Follow the instructions below to avoid personal injury or equipment damage.

1. Consider the weight of the equipment before moving it. Assign enough personnel to move the equipment to avoid personal injury.
2. Wear safety gloves to avoid personal injury.
3. Keep balance when moving the equipment.

### 5.2.2 Installing the Inverter

#### NOTICE

- Avoid the water pipes and cables buried in the wall when drilling holes.
- Wear goggles and a dust mask to prevent the dust from being inhaled or contacting eyes when drilling holes.
- The anti-theft lock of appropriate size should be prepared by customers. Diameter of the lock hole is 10mm.
- Make sure that all the DC input terminals are inside the PV box when installing the box. Install the box cling to the bottom of the inverter.

**Step 1** Put the mounting plate on the wall horizontally and mark positions for drilling holes.

**Step 2** Drill holes to a depth of 80mm using the hammer drill. The diameter of the drill bit should be 10mm.

**Step 3** Secure the mounting plate using the expansion bolts.

**Step 4** Install the inverter on the mounting plate.

**Step 5** Tighten the nuts to secure the mounting plate and the inverter.

**Step 6** Install the anti-theft lock.

**Step 7** (For Australia and New Zealand) Install the PV box and the PV box mounting plate together using the delivered M5 screws.

**Step 8** (For Australia and New Zealand) Drill holes to a depth of 60mm using the hammer drill. The diameter of the drill bit should be 8mm.

**Step 9** (For Australia and New Zealand) Secure the PV box at the bottom of the inverter using the delivered expansion bolts.

**NOTICE**

Installation method of GW4K-DT, GW4000-SDT-20, GW5K-DT, GW5000-SDT-20, GW6K-DT, GW6000-SDT-20, GW10KT-DT, GW12KT-DT, GW15KT-DT inverter:

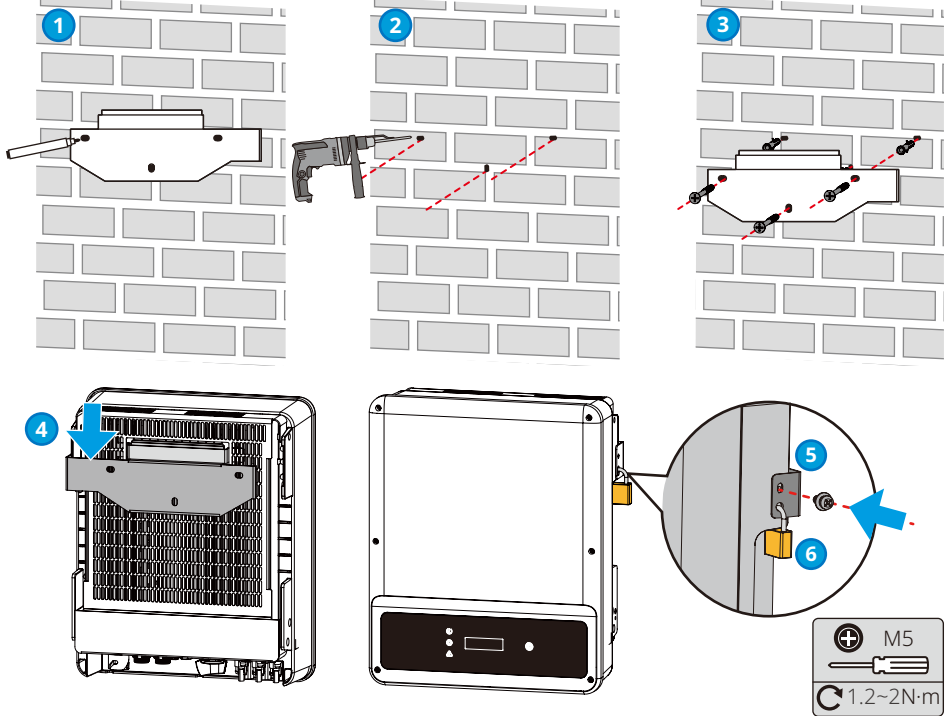

**NOTICE**

Installation method of GW8KAU-DT, GW10KAU-DT, GW15KAU-DT, GW20KAU-DT, GW17KT-DT, GW20KT-DT, GW25KT-DT, GW8000-SDT-20, GW10K-SDT-20, GW12K-SDT-20, GW12KLV-SDT-20, GW15K-SDT-20, GW17K-SDT-20, GW20K-SDT-20 inverter:

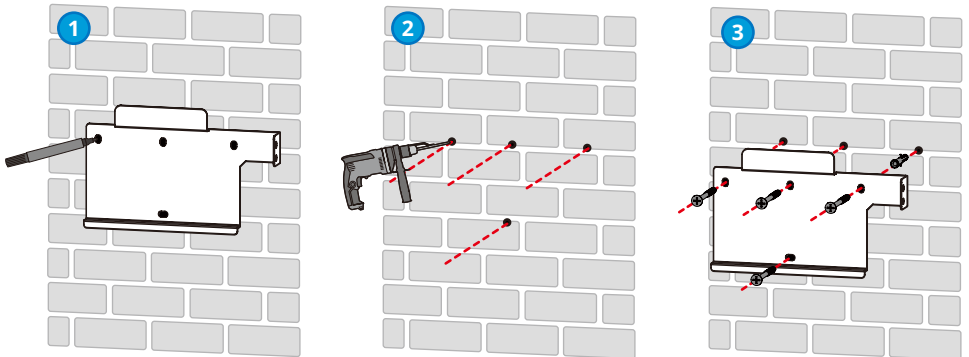

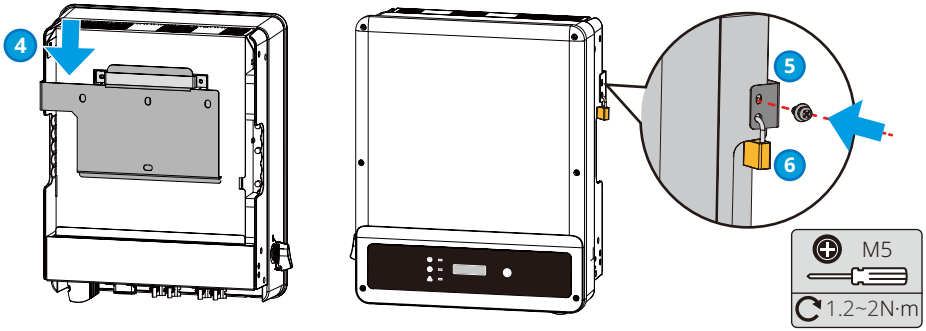

**NOTICE**

For Australia and New Zealand: GW15KAU-DT, GW20KAU-DT.

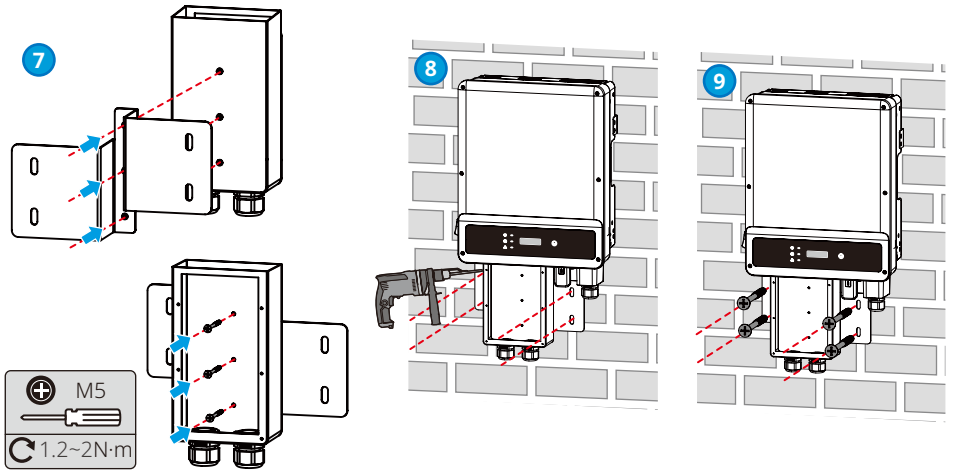

## 6 Electrical Connection

### 6.1 Safety Precautions

#### DANGER

- Disconnect the DC switch and the AC output switch of the inverter to power off the equipment before any electrical connections. Do not work with power on. Otherwise, an electric shock may occur.
- Perform electrical connections in compliance with local laws and regulations. Including operations, cables, and component specifications.
- If the tension is too large, the cable may be poorly connected. Reserve a certain length of the cable before connecting it to the inverter cable port.

#### NOTICE

- Wear personal protective equipment like safety shoes, safety gloves, and insulating gloves during electrical connections.
- All electrical connections should be performed by qualified professionals.
- Cable colors in this document are for reference only. The cable specifications should meet local laws and regulations.

### 6.2 Connecting the PE Cable

#### WARNING

- The PE cable connected to the enclosure of the inverter cannot replace the PE cable connected to the AC output port. Both of the two PE cables must be securely connected.
- Make sure that all the grounding points on the enclosures are equipotential connected when there are multiple inverters.
- To improve the corrosion resistance of the terminal, it is recommended to apply silica gel or paint on the ground terminal after installing the PE cable.
- The PE cable should be prepared by customers. Recommended specifications:
  - Type: single-core outdoor copper cable.
  - Conductor crosssectional area  $S \geq 10\text{mm}^2$  (GW8000-SDT-20, GW10K-SDT-20, GW12K-SDT-20, GW12KLV-SDT-20, GW15K-SDT-20, GW17K-SDT-20, GW20K-SDT-20).
  - Conductor crosssectional area  $S \geq 4\text{mm}^2$  (Other models).

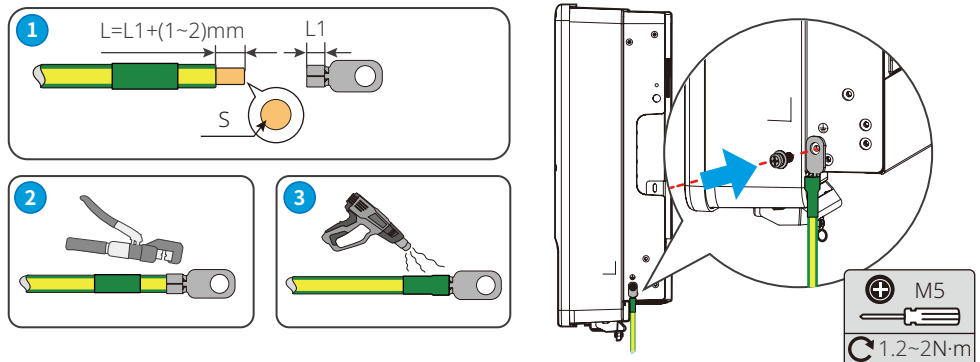

### 6.3 Connecting the PV Input Cable

#### **⚠ DANGER**

Confirm the following information before connecting the PV string to the inverter. Otherwise, the inverter may be damaged permanently or even cause fire and cause personal and property losses.

1. Make sure that the max short circuit current and the max input voltage per MPPT are within the permissible range.
2. Make sure that the positive pole of the PV string connects to the PV+ of the inverter. And the negative pole of the PV string connects to the PV- of the inverter.
3. The minimum impedance to earth of the PV module shall be greater than R.  $R = \frac{\text{Max.Input Voltage (V)}}{30\text{mA}}$ , i.e.  $R = \frac{1100\text{V}}{30\text{mA}} = 36.7\text{K}\Omega$  or  $R = \frac{1000\text{V}}{30\text{mA}} = 33.4\text{K}\Omega$ .

#### **⚠ WARNING**

- Connect the DC cables using the delivered PV connectors. The manufacturer shall not be liable for the damage if other connectors are used.
- The PV strings cannot be grounded. Ensure the minimum isolation resistance of the PV string to the ground meets the minimum isolation resistance requirements before connecting the PV string to the inverter.
- The DC input cable should be prepared by customers. Recommended specifications:
  - Type: the outdoor photovoltaic cable that meets the maximum input voltage.
  - Conductor cross-sectional area: 2.5~4mm<sup>2</sup>

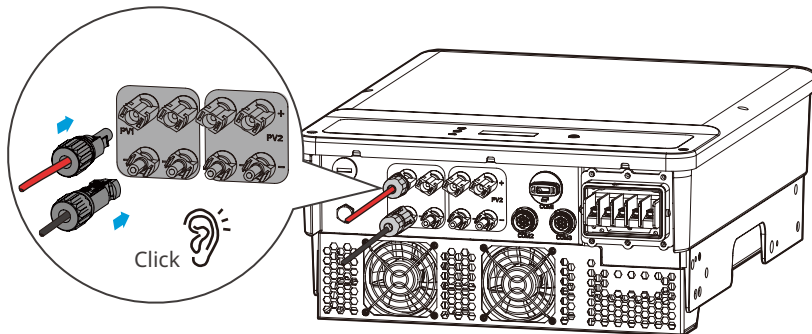

**NOTICE**

Seal the PV input terminals using waterproof covers when they are not to be used. Otherwise, the ingress protection rating will be influenced.

**Connecting the DC Input Cable(with PV box)****NOTICE**

The PV box should be installed when GW15KAU-DT or GW20KAU-DT is used in Australia and in New Zealand. Install the cover of the PV box after connecting the DC input cable to the equipment.

**Step 1** Route the DC cables into the PV box.

**Step 2** Prepare DC cables.

**Step 3** Crimp the crimp contacts.

**Step 4** Disassemble the PV connectors.

**Step 5** Make the DC cable and detect the DC input voltage.

**Step 6** Plug the PV connectors into the PV terminals.

**Step 7** Install the PV box cover.

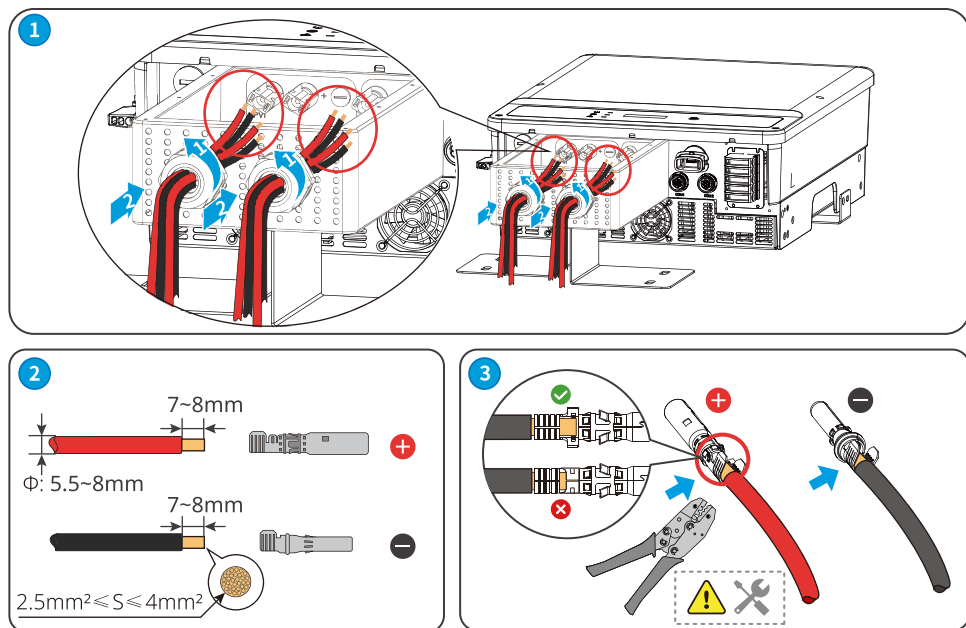
**Devalan DC Connector**

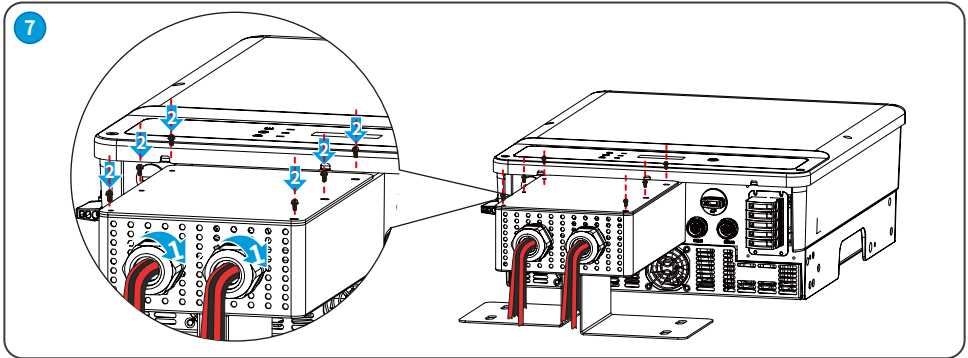
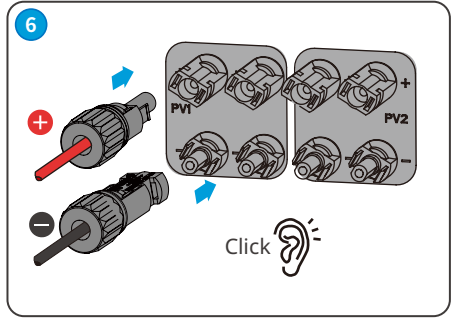
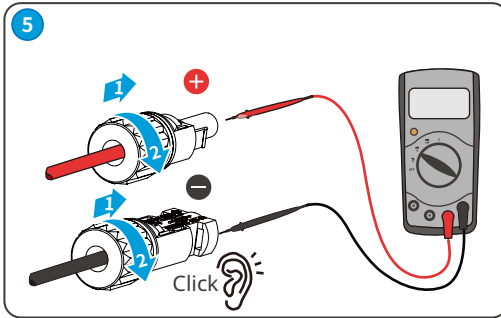
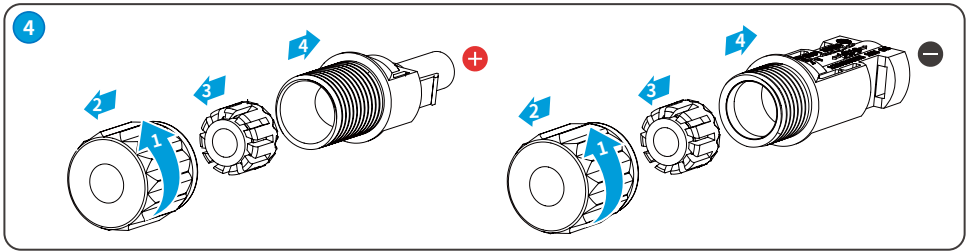

**Staubli MC4 DC Connector**

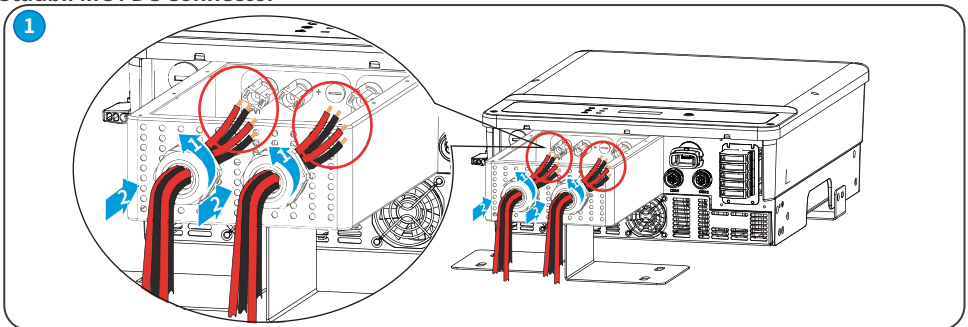



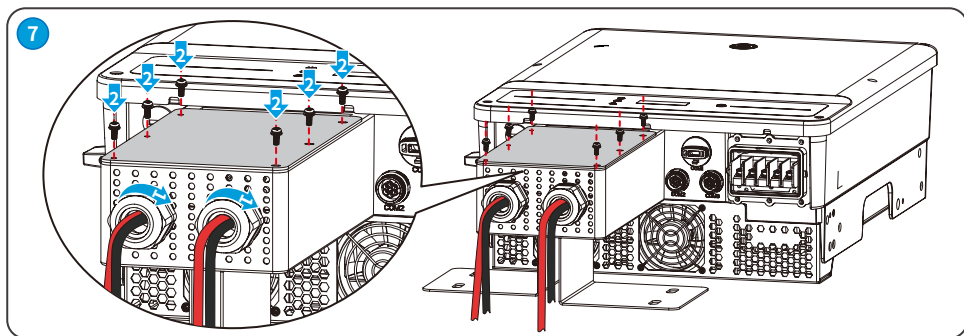
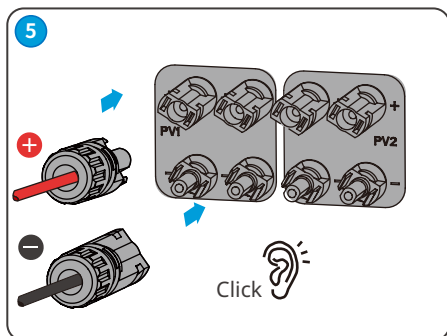
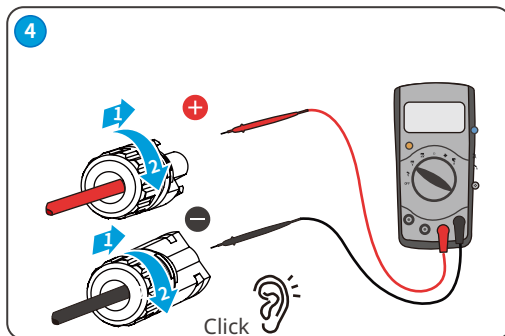
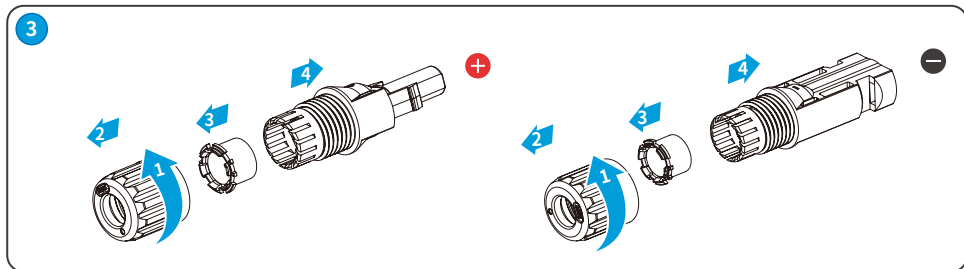
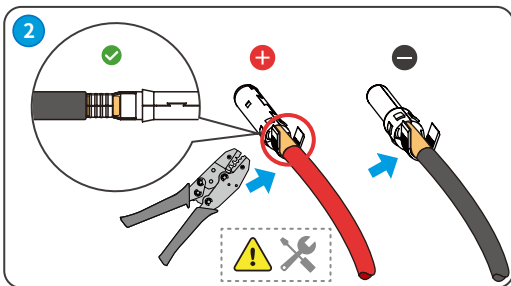
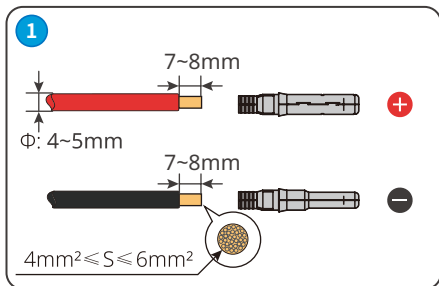

### Connecting the DC Input Cable (without PV box)

**Step 1** Prepare DC cables.

**Step 2** Crimp the crimp contacts.

**Step 3** Disassemble the PV connectors.

**Step 4** Make the DC cable and detect the DC input voltage.

**Step 5** Plug the PV connectors into the PV terminals.

#### Devalan DC Connector

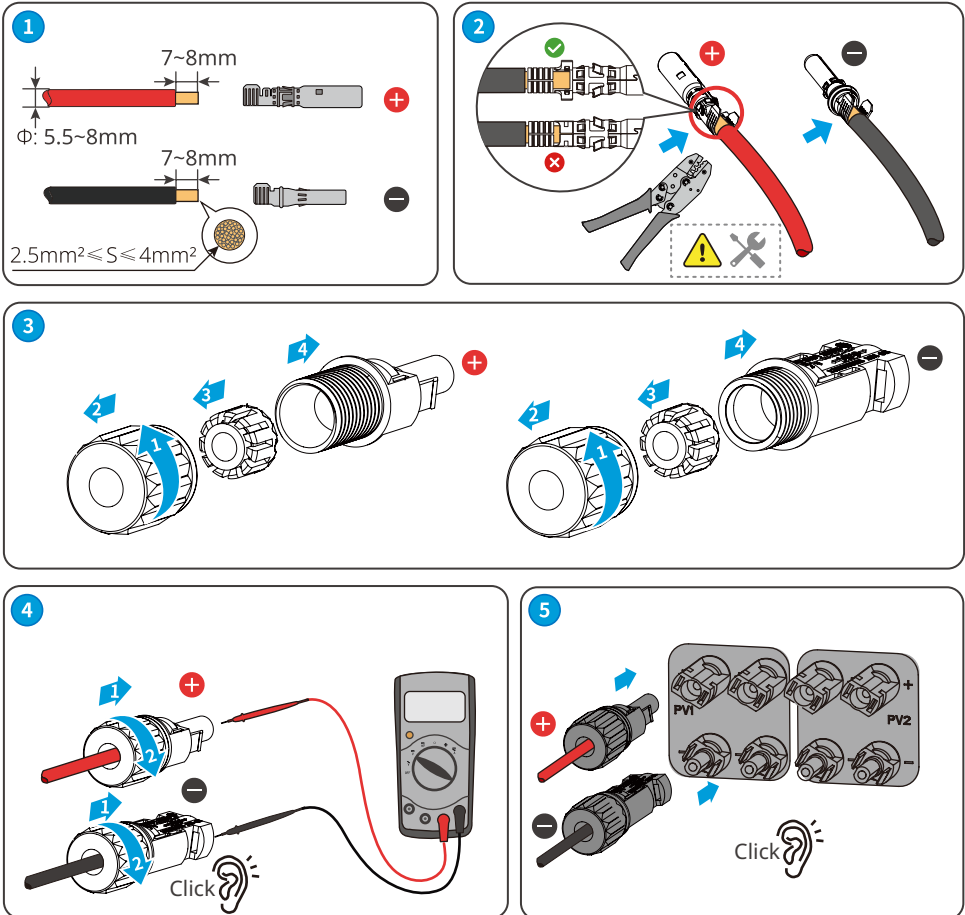

### Staubli MC4 DC Connector

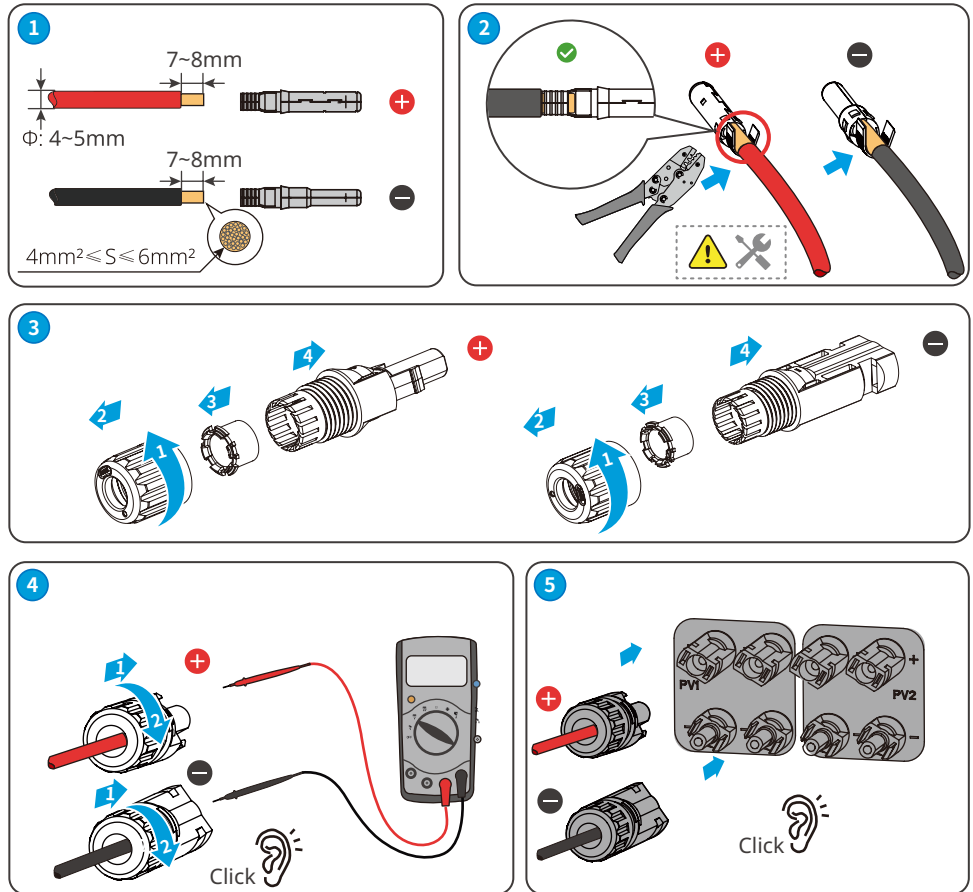

## 6.4 Connecting the AC Output Cable

### WARNING

- Do not connect loads between the inverter and the AC switch directly connected to it.
- Where an external RCD (Residual Current Device) is required in addition to the built-in RCMU (Residual Current Monitoring Unit), a type A RCD must be used to avoid tripping. The action current of RCD should be 300mA or higher.

An AC circuit breaker should be installed on the AC side to make sure that the inverter can safely disconnect the grid when an exception happens. Select the appropriate AC circuit breaker in compliance with local laws and regulations. Recommended AC circuit breakers:

Inverter model	AC circuit breaker
GW4K-DT, GW4000-SDT-20, GW5K-DT, GW5000-SDT-20, GW6K-DT, GW6000-SDT-20	16A
GW8K-DT, GW8KAU-DT, GW10KT-DT, GW10KAU-DT, GW8000-SDT-20, GW10K-SDT-20,	25A
GW12KT-DT, GW15KT-DT, GW15KAU-DT, GW17KT-DT, GW12K-SDT-20, GW12KLV-SDT-20, GW15K-SDT-20	32A
GW20KT-DT, GW20KAU-DT, GW17K-SDT-20, GW20K-SDT-20	40A
GW25KT-DT	50A

### NOTICE

Install one AC circuit breaker for each inverter. Multiple inverters cannot share one AC circuit breaker.

Cable Type	Five-core outdoor copper cable
Outside Diameter	4-10kW: $13\text{mm} \leq \Phi \leq 18\text{mm}$ 12-15kW: $18\text{mm} \leq \Phi \leq 25\text{mm}$
Conductor cross-sectional area	4-10kW: $4\text{mm}^2 \leq S \leq 10\text{mm}^2$ 12-15kW: $6\text{mm}^2 \leq S \leq 16\text{mm}^2$

### WARNING

- Pay attention to the silkscreens L1, L2, L3, N, PE on the AC terminal. Connect the AC cables to the corresponding terminals. The inverter may be damaged if the cables are connected inappropriately.
- Make sure that the whole cable cores are inserted into the AC terminal holes. No part of the cable core can be exposed.
- Make sure that the cables are connected securely. Otherwise, the terminal may be too hot to damage the inverter when the inverter is working.
- Reserve certain length of PE cable. Make ensure that the PE cable is the last one to bear the stress when the AC output cable is under tension.

**NOTICE**

GW4K-DT, GW4000-SDT-20, GW5K-DT, GW5000-SDT-20, GW6K-DT, GW6000-SDT-20, GW10KT-DT, GW12KT-DT, GW15KT-DT

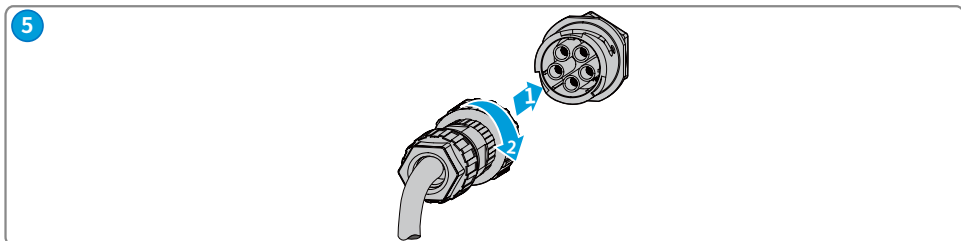
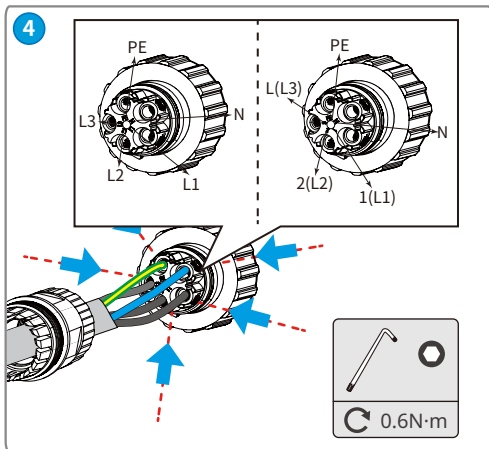
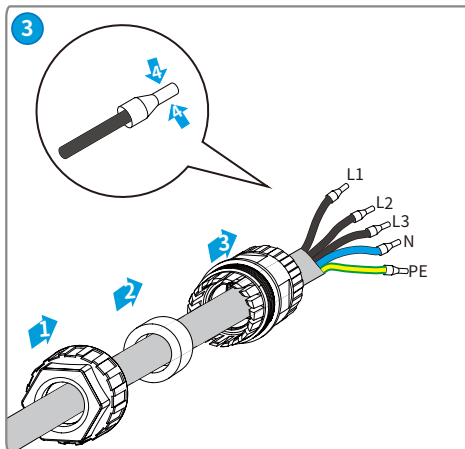
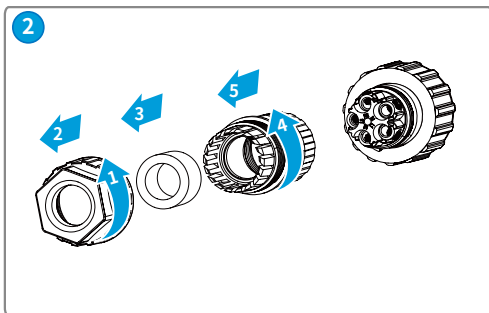
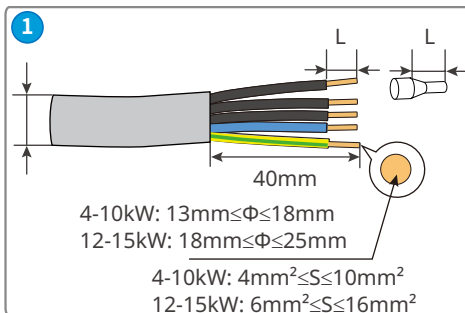
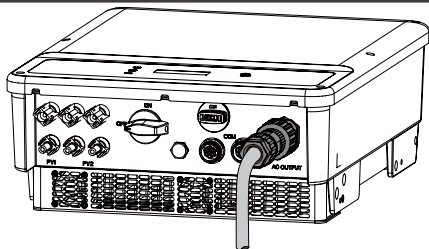

**NOTICE**

For models: GW8000-SDT-20, GW10K-SDT-20, GW12K-SDT-20, GW12KLV-SDT-20, GW15K-SDT-20, GW17K-SDT-20, GW20K-SDT-20.

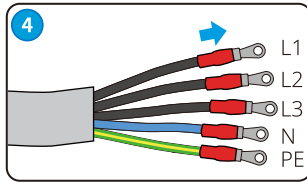
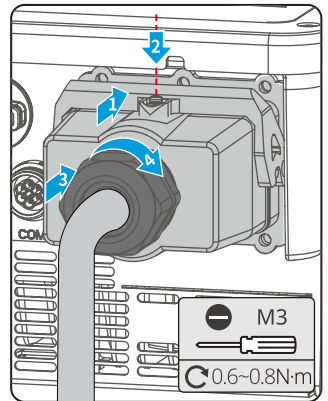
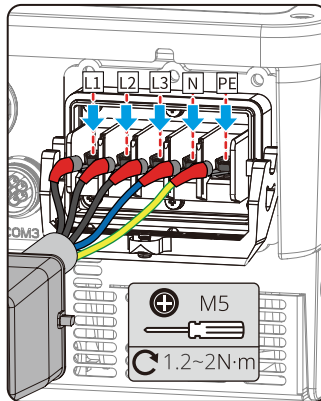
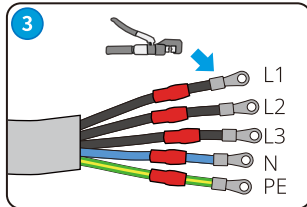
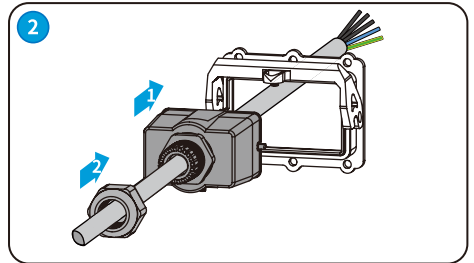
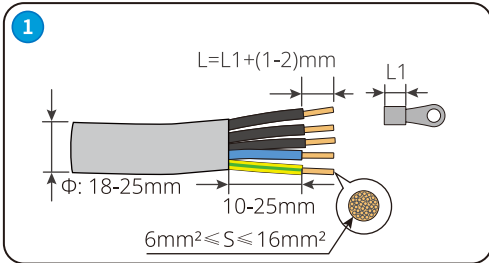
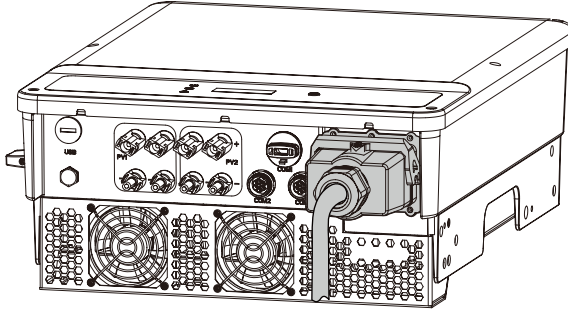

**NOTICE**

- Make sure that the cables are connected correctly and firmly after connections. Clean all the debris in the maintenance compartment.
- Seal the AC output terminal to ensure the Ingress Protection Rating.

**NOTICE**

For models: GW8KAU-DT, GW10KAU-DT, GW15KAU-DT, GW20KAU-DT, GW17KT-DT, GW20KT-DT, GW25KT-DT.

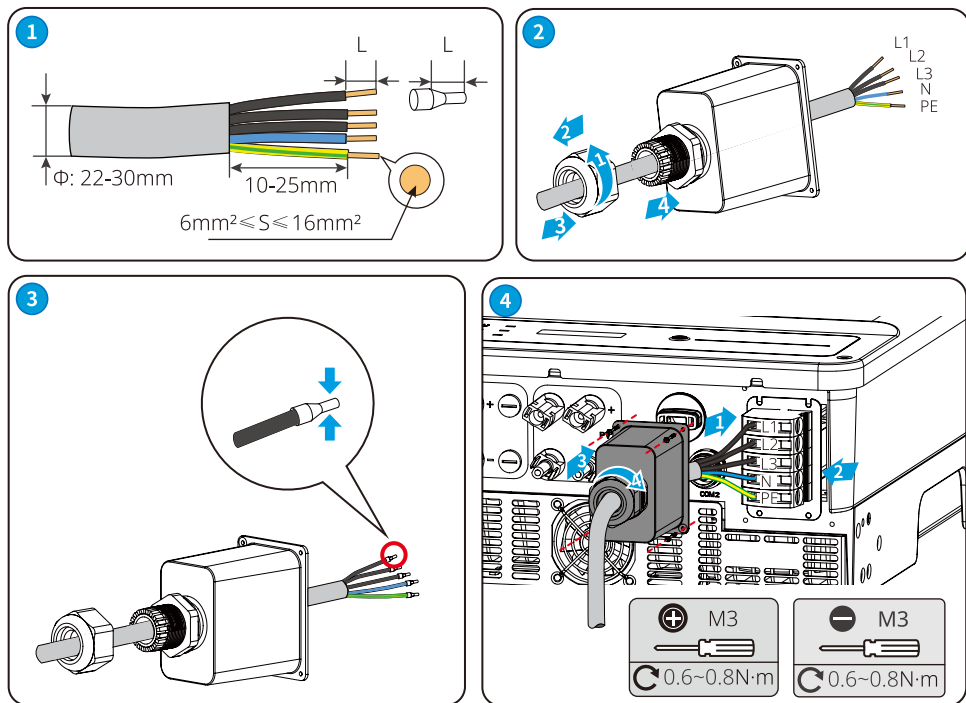
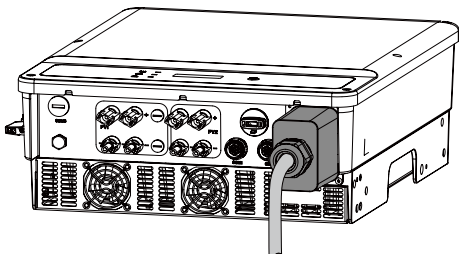
**NOTICE**

- Make sure that the cables are connected correctly and firmly after connections. Clean all the debris in the maintenance compartment.
- Seal the AC output terminal to ensure the Ingress Protection Rating.

## 6.5 Communication

### 6.5.1 Connecting the Communication Cable (optional)

#### NOTICE

Make sure that the communication device is connected to the right COM port. Route the communication cable far away from any interference source or power cable to prevent the signal from being influenced.

Communication Type	Port Definition	Function Description
RS485	1: RS485 B 2: RS485 B 3: RS485 A 4: RS485 A	Used to connect the inverter to other inverters or the RS485 port on the data logger.
Meter Communication	5: Meter + 6: Meter -	Realize the anti-backfeed function by connecting the meter and the CT. Contact the manufacturer to purchase the devices if you need them.
DRED	1: DRM1/5 2: DRM2/6 3: DRM3/7 4: DRM4/8 5: REFGen 6: Com/DRM0	The DRED port is reserved in compliance to grid regulations in Australia and New Zealand. Related devices should be prepared by customers. Contact the after-sales service to get the DRED terminal if you need to use DRED function. DRED function is off by default. Start this function via SolarGo App if it's needed.
Remote Shutdown	+: DRM4/8 -: REFGen	The Remote Shutdown port is reserved in compliance to grid regulations in Europe. Related devices should be prepared by customers. Remote Shutdown function is off by default. Start this function via SolarGo App if it's needed.



### Power limit networking scenario (single inverter)

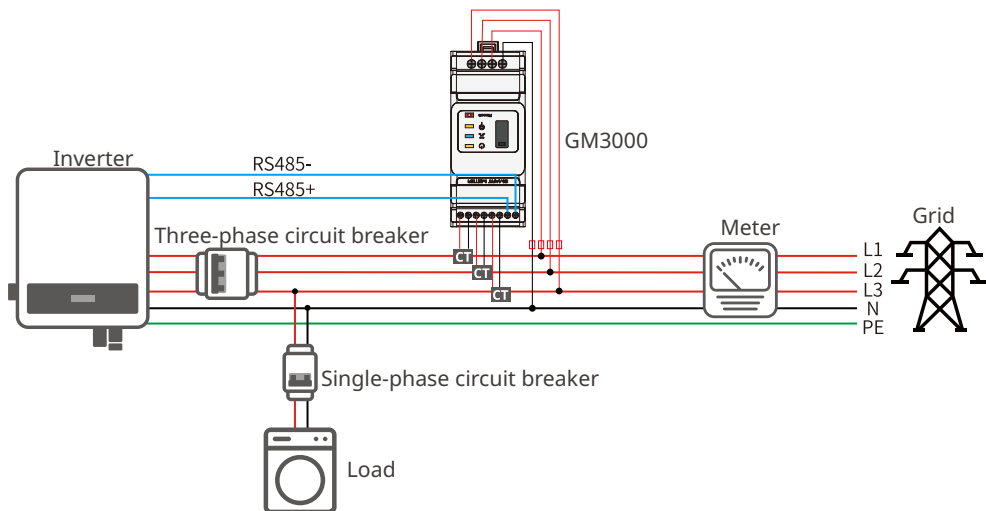

### Power limit networking scenario (multi inverters)

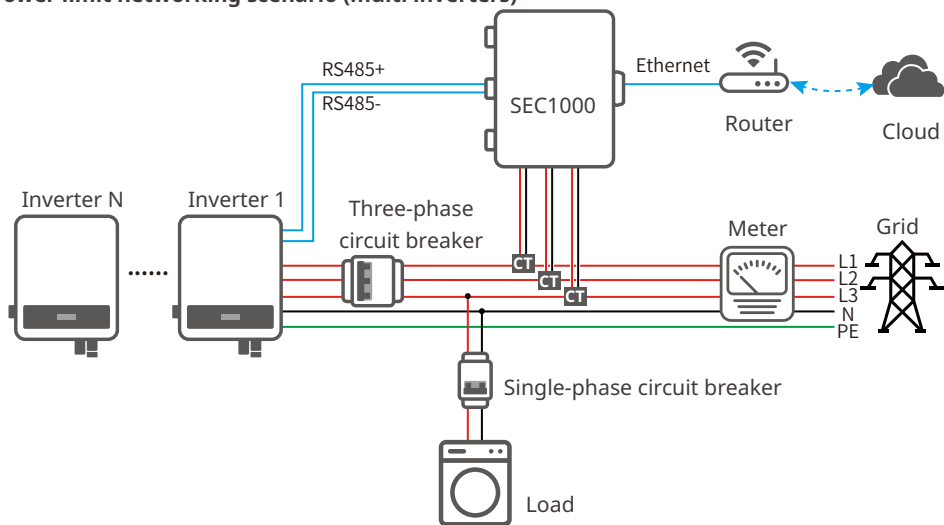

Connecting the Communication Cable(RS485, Meter, and DRED)

**NOTICE**

Connect the RS485 cable, meter cable, and DRED cable using a 6PIN communication terminal as follows.

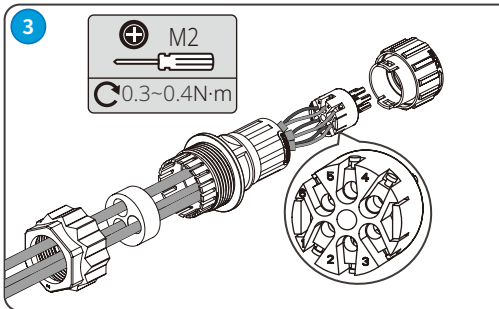
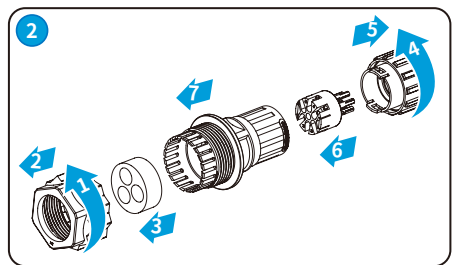
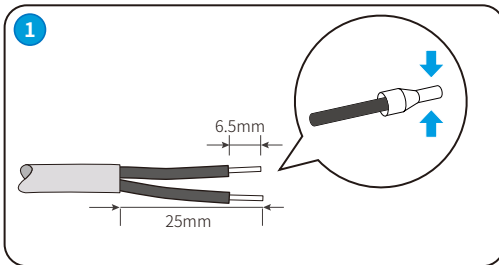
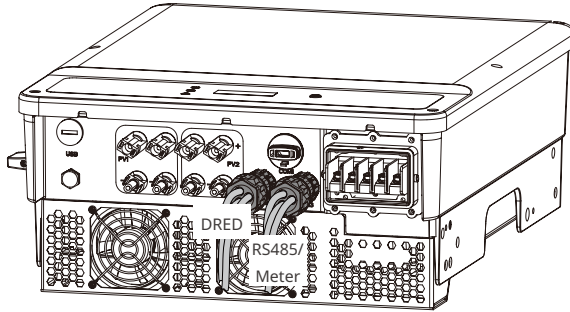

RS485/Meter	DRED
1: RS485 B	1: DRM1/5
2: RS485 B	2: DRM2/6
3: RS485 A	3: DRM3/7
4: RS485 A	4: DRM4/8
5: Meter +	5: REFGen
6: Meter -	6: Com/DRM0

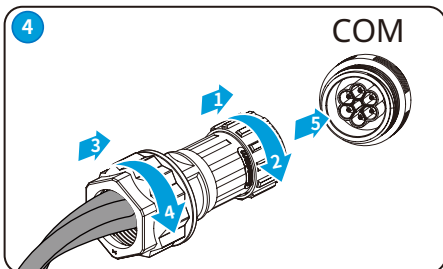

**NOTICE**

For Australia and New Zealand:  
Do not remove the pre-installed terminal when the DRED function is not applied. Install the terminal back to the inverter when the DRED function is not to be used for the moment. The inverter cannot be grid-tied if the DRED terminal is removed.

### Connecting the Communication Cable(RS485, Meter, and Remote shutdown)

#### NOTICE

Connect the remote shutdown cable using a 2PIN communication terminal as follows.

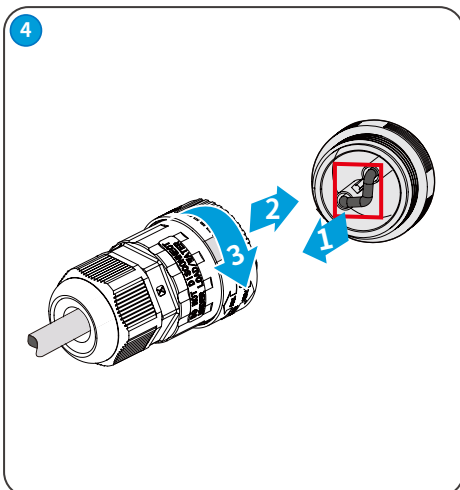
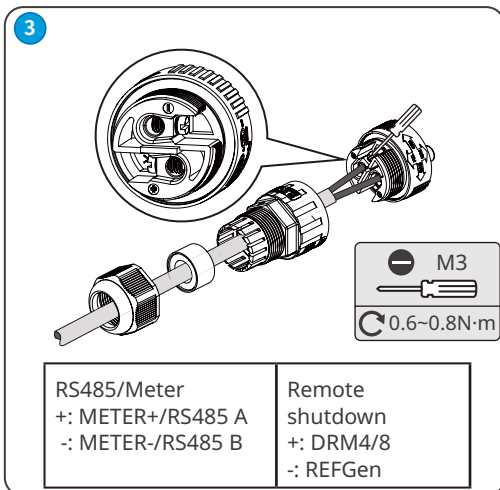
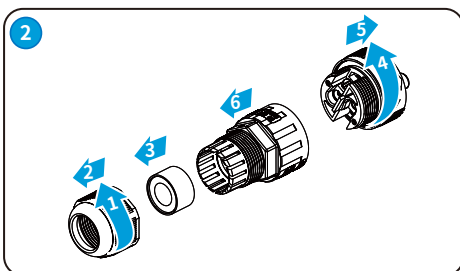
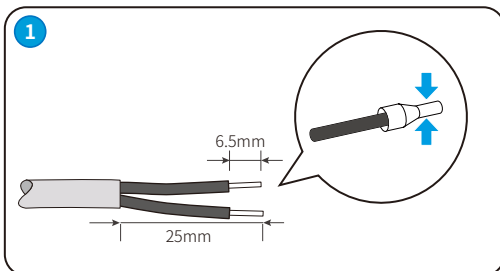
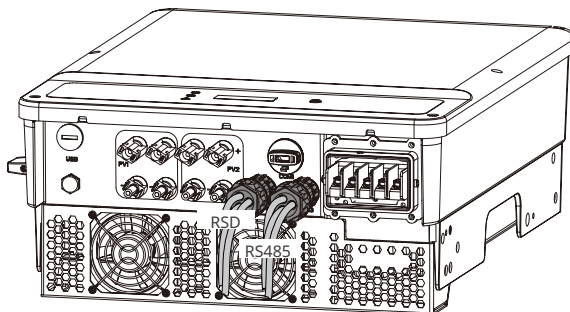

## Connecting the Communication Cable(USB)

USB Port: For Brazil only.

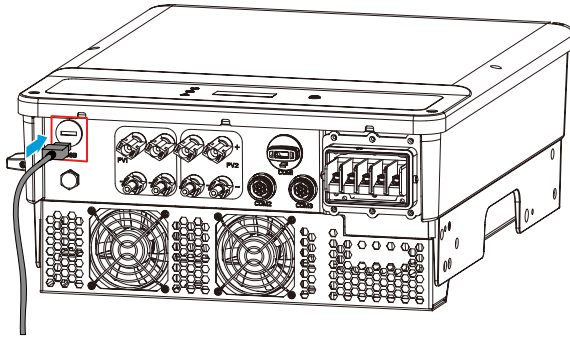

### 6.5.2 Installing the Communication Module (optional)

Plug a communication module into the inverter to establish a connection between the inverter and the smartphone or web pages. The communication module can be a Bluetooth module, WiFi module, LAN module, or 4G module. Set inverter parameters, check running information and fault information, and observe system status in time via the smartphone or web pages.

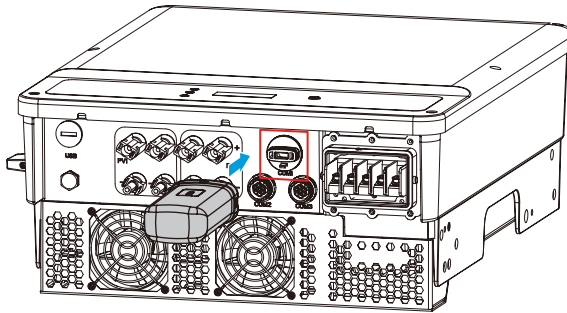

#### NOTICE

- Refer to the delivered communication module user manual to get more introduction to the module. For more detailed information, visit <https://en.goodwe.com/>.
- Remove the communication module using the unlock tool. The manufacturer shall not be liable for the port damage if the module is removed without the unlock tool.

## 7 Equipment Commissioning

### 7.1 Check Items Before Switching Power ON

No.	Check Item
1	The inverter is firmly installed in a clean place where is well-ventilated and easy to operate.
2	The PE cable, DC input cable, AC output cable, and communication cable are connected correctly and securely.
3	Cable ties are routed properly and evenly, and no burrs.
4	Unused ports and terminals are sealed.
5	The voltage and frequency at the connection point meet the on-grid requirements.

### 7.2 Power On

**Step 1** Turn on the AC switch between the inverter and the utility grid.

**Step 2** (optional) Turn on the DC switch between the inverter and the PV string.

**Step 3** Turn on the DC switch between the inverter and the PV String.

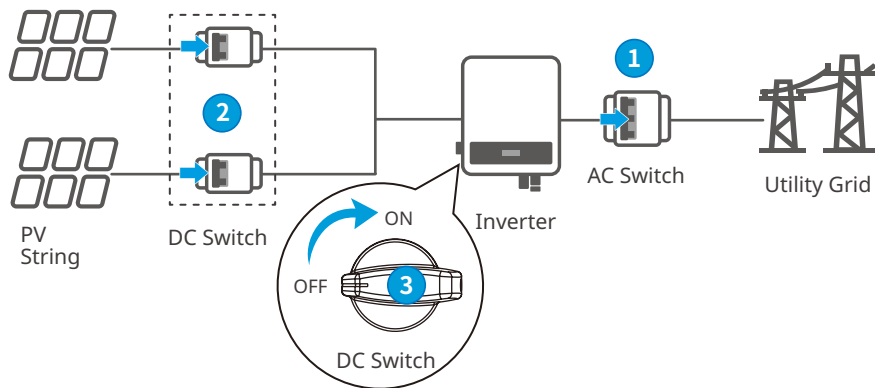







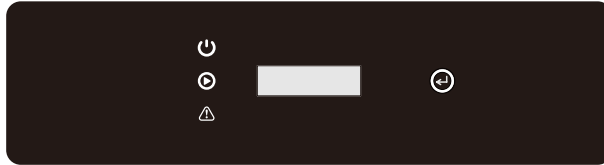





## 8 System Commissioning

### 8.1 Indicators and Button









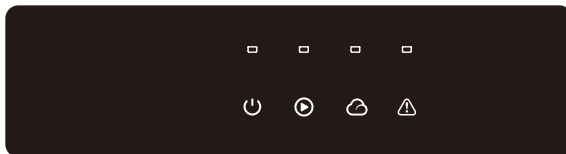









#### Inverters Designed with LCD

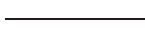

Type	Status	Description
 Power		Steady yellow Communication status is normal.
		Single yellow blinking Communication is resetting or restarting.
		Double yellow blinking The inverter is not connected to the router.
		Quadruple yellow blinking The inverter is not connected to the server.
		Yellow blinking RS485 is working normally.
		Off No communication.
 Operating		Steady green The inverter is grid-tied successfully.
		Off The inverter is off grid.
 Alarming		Steady red System fault.
		Off No fault.

### Inverters Designed without LCD



Type	Status		Description
 Power		Steady Green	Power on.
		Off	Power off.
 Operating		Steady Green	The power grid is working normally. The inverter is on grid.
		Off	The inverter is off grid.
		Single Green Slow Blinking	Self-check before grid tying.
		Single Green Fast Blinking	The inverter is to be grid-tied.
 SEMS		Steady green	The Communication module is working properly.
		Quartic Green Blinking	The inverter is not connected to the server.
		Double Green Blinking	The inverter is not connected to the router.
		Single Green Slow Blinking	RS485 is working normally.
		Single Green Fast Blinking	Communication is resetting or restarting.
		Off	No communication.
 Alarming		Steady Red	System Fault.
		Off	No fault.

### LCD Button Description

Stop pressing the button for a period in any page, the LCD will get dark and go back to the initial page, which means the parameter in that page has been saved successfully.

## 8.2 Setting Inverter Parameters via LCD

### NOTICE

- Inverter software version shown in this document is V1.00.00.13. The screen shots are for reference only. The actual display may differ.
- The name, range, and default value of the parameters is subject to change or adjust. The actual display prevails.
- the power parameters should be set by professionals to prevent the generating capacity from being influenced by wrong parameters

### 8.2.1 LCD Menu Introduction

This part describes the menu structure, allowing you view inverter information and set parameters more conveniently.

#### Main menu

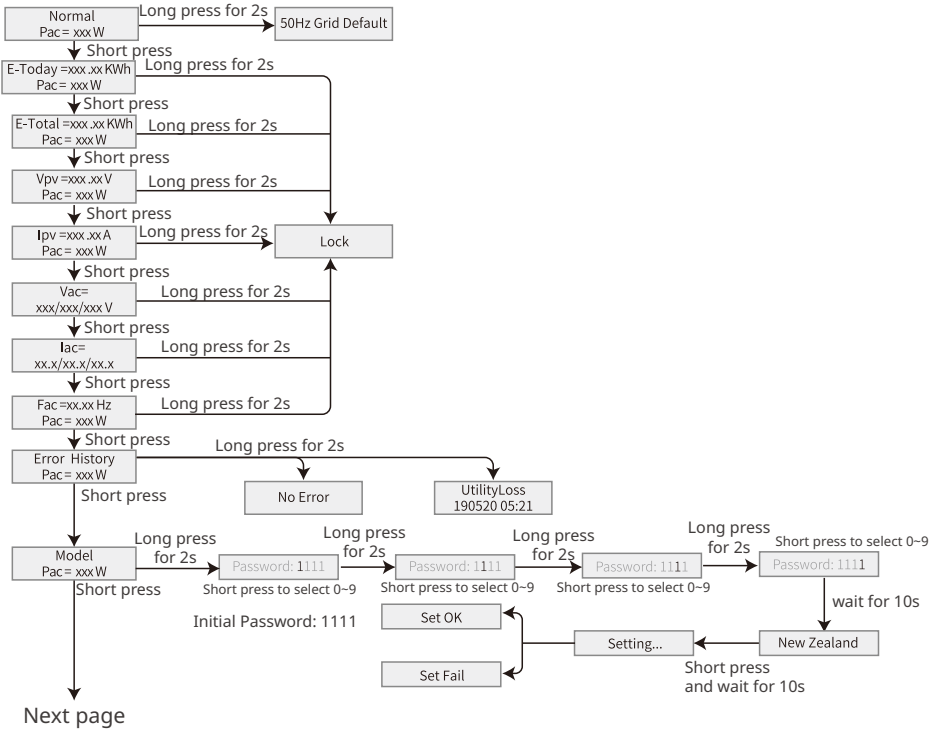



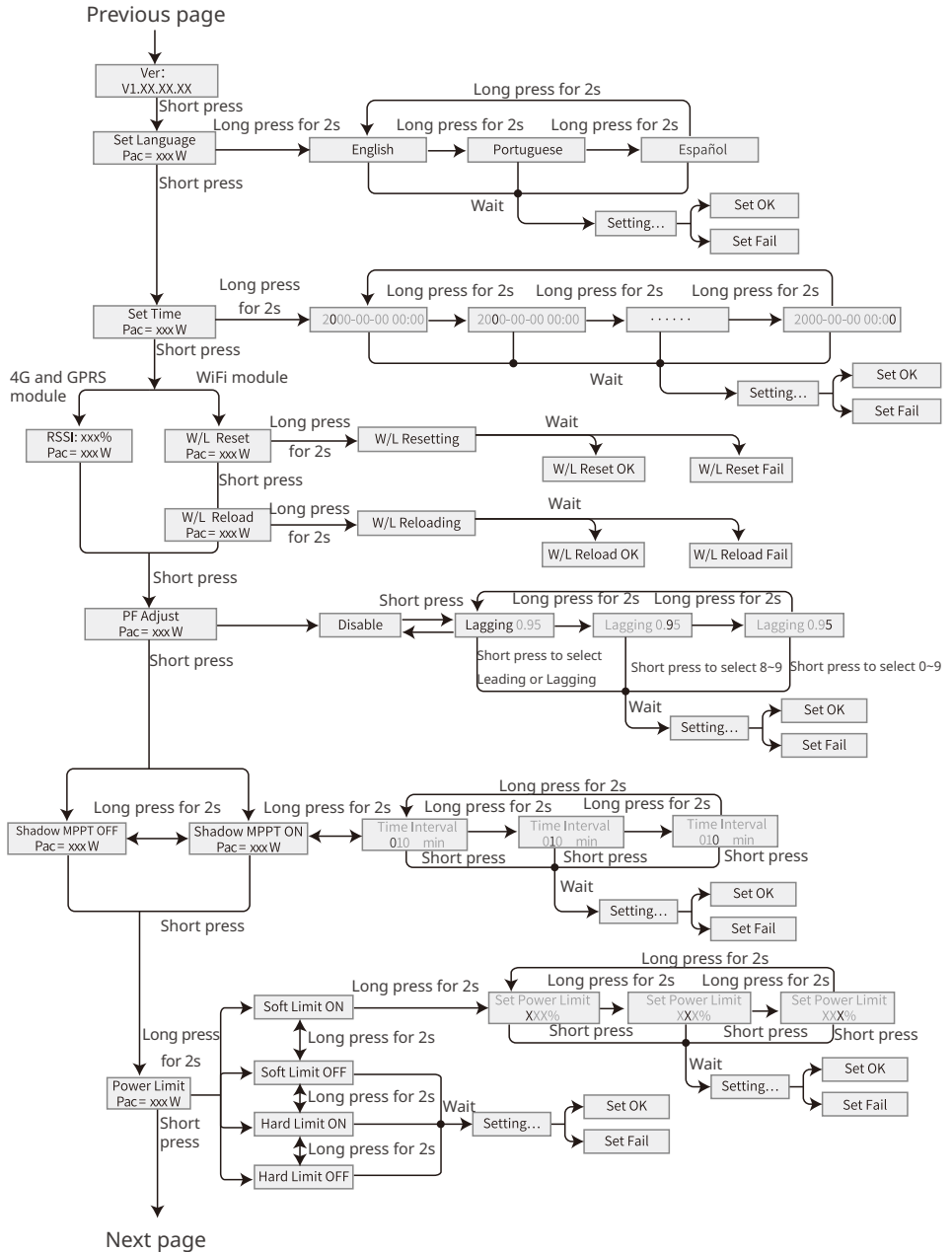

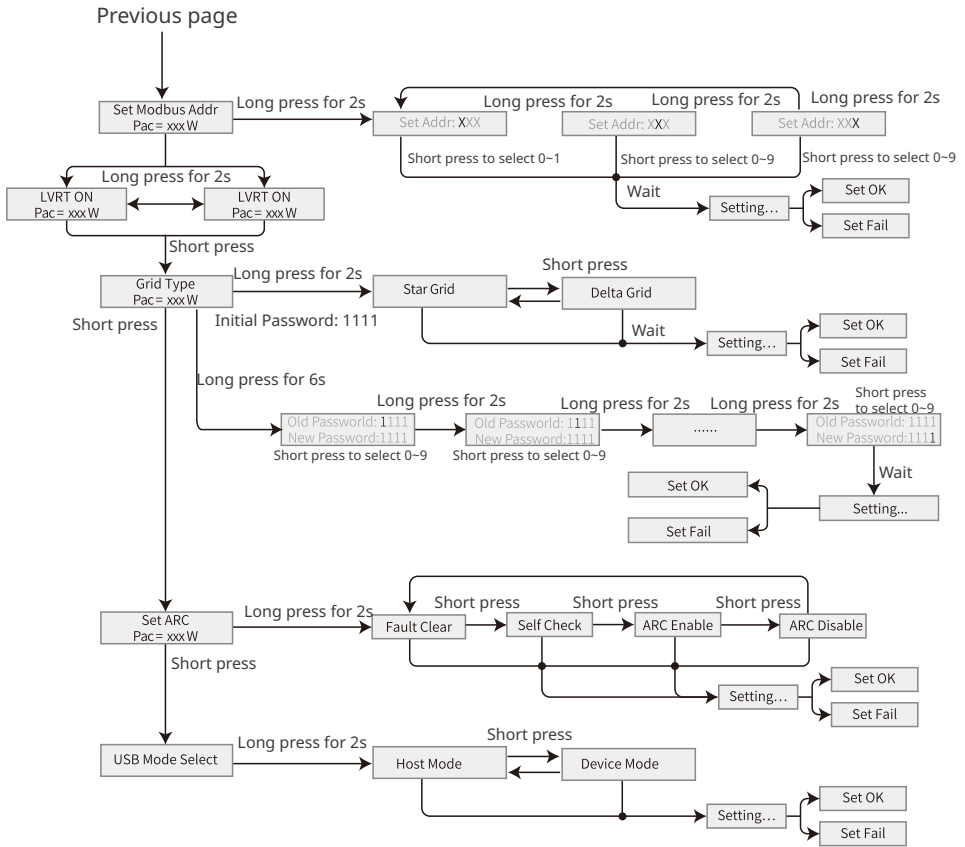

### 8.2.2 Inverter Parameter Introduction

Parameters	Description
Normal	Home page. Indicates the real-time power of the inverter. Long press for 2s to check the current safety code.
E-Today	Check the generated power of the system for that day.
E-Total	Check the total generated power of the system.
Vpv	Check the DC input voltage of the inverter.
Ipv	Check the DC input current of the inverter.
Vac	Check the voltage of the utility grid.
Iac	Check the AC output current of the inverter.
Fac	Check the frequency of the utility grid.

Parameters	Description
Error History	Check historical error message records of the inverter.
Model	Indicates the specific inverter model. Long press for 2s to set the safety code. Set the safety country in compliance with the local grid standards and application scenario of the inverter.
Ver	Check the software version.
Set Language	Set language accordingly. Languages: English, Portuguese, Spanish.
Set Time	Set time according to the actual time in the country/region where the inverter is located.
RSSI	Indicates the received signal strength of the GPRS module and 4G module.
W/L Reset	Power off and restart the WiFi module.
W/L Reload	Restore the factory settings of the WiFi module. Reconfigure the WiFi module network parameters after restoring the factory settings,
PF Adjust	Set the power factor of the inverter according to actual situation.
Time Interval	Set Time Interval according to actual needs.
Shadow MPPT	Enable the shadow scan function if the PV panels are shadowed.
Power Limit	<b>Soft limit:</b> Set the power feed into the utility grid according to local requirements and standards. <b>Hard limit:</b> The inverter and the utility grid will automatically disconnect when the power feeds into the grid exceeds the required limit.
Set Power Limit	Set the power feed back into the utility grid according to the actual situation.
Set Modbus Addr	Set the actual Modbus address.
LVRT	With LVRT on, the inverter will stay connected with the utility grid when a short-term utility grid low voltage exception occurs.
HVRT	With HVRT on, the inverter will stay connected with the utility grid when a short-term utility grid high voltage exception occurs.
Grid Type	Set the grid type according to the actual grid type. Supported grid type: star grid and delta grid.
Set ARC	ARC is optional and off by default. Enable or disable ARC accordingly.
Fault Clear	Clear ARC alarm records.
Self Check	Check whether ARC can work normally.
USB Mode Select	Reserved for troubleshooting by after-sales service staff.

### 8.3 Setting Inverter Parameters via App

SolarGo is an application used to communicate with the inverter via Bluetooth module, WiFi module, or GPRS module. Commonly used functions:

1. Check the operating data, software version, alarms of the inverter, etc.
2. Set grid parameters and communication parameters of the inverter.
3. Maintain the equipment.

For more details, refer to the SolarGo APP User Manual. Scan the QR code or visit [https://en.goodwe.com/Ftp/EN/Downloads/User%20Manual/GW\\_SolarGo\\_User%20Manual-EN.pdf](https://en.goodwe.com/Ftp/EN/Downloads/User%20Manual/GW_SolarGo_User%20Manual-EN.pdf) to get the user manual.



SolarGo App



SolarGo App  
User Manual

### 8.4 Monitoring via SEMS Portal

SEMS Portal is an monitoring platform used to manage organizations/users, add plants, and monitor plant status.

For more details, refer to the SEMS Portal User Manual. Scan the QR code or visit [https://en.goodwe.com/Ftp/EN/Downloads/User%20Manual/GW\\_SEMS%20Portal-User%20Manual-EN.pdf](https://en.goodwe.com/Ftp/EN/Downloads/User%20Manual/GW_SEMS%20Portal-User%20Manual-EN.pdf) to get the user manual.



SEMS Portal



SEMS Portal  
User Manual

## 9 Maintenance

### 9.1 Power Off the Inverter

#### DANGER

- Power off the inverter before operations and maintenance. Otherwise, the inverter may be damaged or electric shocks may occur.
- Delayed discharge. Wait until the components are discharged after power off.

**Step 1** (optional) Send shutdown command to the inverter,

**Step 2** Turn off the AC switch between the inverter and the utility grid.

**Step 3** Turn off the DC switch of the inverter.

**Step 4** (optional) Turn off the DC switch between the inverter and the PV string.

### 9.2 Removing the Inverter

#### WARNING

- Make sure that the inverter is powered off.
- Wear proper PPE before any operations.

**Step 1** Disconnect all the cables, including DC cables, AC cables, communication cables, the communication module, and PE cables.

**Step 2** Remove the inverter from the mounting plate.

**Step 3** Remove the mounting plate.

**Step 4** Store the inverter properly. If the inverter needs to be used later, ensure that the storage conditions meet the requirements.

### 9.3 Disposing of the Inverter

If the inverter cannot work any more, dispose of it according to the local disposal requirements for electrical equipment waste. Do not dispose of it as household waste.

### 9.4 Troubleshooting

Perform troubleshooting according to the following methods. Contact the after-sales service if these methods do not work.

Collect the information below before contacting the after-sales service, so that the problems can be solved quickly.

1. Inverter information like serial number, software version, installation date, fault time, fault frequency, etc.
2. Installation environment, including weather conditions, whether the PV modules are sheltered or shadowed, etc. It is recommended to provide some photos and videos to assist in analyzing the problem.
3. Utility grid situation.

No.	Fault	Cause	Solutions
1	Ver. Error	Wrong software version.	Contact after-sales service to upgrade the software.
2	Utility Loss	<ol style="list-style-type: none"> <li>1. Utility grid power failure.</li> <li>2. The AC circuit or the AC breaker is disconnected.</li> </ol>	<ol style="list-style-type: none"> <li>1. Check whether other electrical devices under the same grid connection point is working normally and whether the main supply is normal.</li> <li>2. Make sure that the upstream switches of the inverter are connected.</li> <li>3. Make sure that the phase sequence of the AC cables are connected correctly, and the neutral wire and PE cable are connected properly and firmly.</li> </ol>
3	Vac Fail	The utility grid voltage is out of the allowed range.	<ol style="list-style-type: none"> <li>1. Make sure that the grid voltage is within the allowed range.</li> <li>2. Make sure that the phase sequence of the AC cables are connected correctly, and the neutral wire and PE cable are connected properly and firmly.</li> </ol>
4	Fac Fail	The utility grid frequency is out of the allowed range.	<ol style="list-style-type: none"> <li>1. Check whether other electrical devices under the same grid connection point is working normally, and whether the main supply is normal.</li> <li>2. Make sure that the grid frequency is within the allowed range.</li> <li>3. Make sure that the phase sequence of the AC cables are connected correctly, and the neutral wire and PE cable are connected properly and firmly.</li> <li>4. Pay attention to the frequency of the fault. If it happens occasionally, the fault may be caused by the instantaneous utility grid frequency change and does not need to be handled.</li> </ol>

No.	Fault	Cause	Solutions
5	Isolation Fail	<ol style="list-style-type: none"> <li>1. The PV system is short-circuited to the ground.</li> <li>2. The PV system is in a moist environment and the circuit is not well insulated to the ground.</li> </ol>	<ol style="list-style-type: none"> <li>1. Check whether the PV input cables are broken.</li> <li>2. Check whether the module frames and the metal bracket are securely grounded.</li> <li>3. Check whether the AC side is properly grounded</li> </ol> <p>Inverters sold in Australia and New Zealand will also alarm as following when Isolation Fail occurs.</p> <ol style="list-style-type: none"> <li>1. Inverters support WiFi communication: An email about the fault will be sent to the user automatically.</li> <li>2. Inverters do not support WiFi communication: The buzzer in the inverter will sound for 1 minute. If the problem persists, the buzzer will sound every 30 min.</li> </ol>
6	DC inject High	DC injection exceeds the allowed range.	<ol style="list-style-type: none"> <li>1. Check whether the software version is the latest one.</li> <li>2. Restart the inverter and check whether the inverter can work properly.</li> </ol>
7	Ground I Fail	The input insulation impedance to the ground decreases when the inverter is operating.	<ol style="list-style-type: none"> <li>1. Check whether the working environment of the inverter meets the requirements. For example, the fault may occur due to high humidity on rainy days</li> <li>2. Make sure that the components are properly grounded and the AC side is properly grounded.</li> </ol>
8	PV Over Voltage	Excess PV modules are connected in the series, and the open-circuit voltage is higher than the operating voltage.	<ol style="list-style-type: none"> <li>1. Check whether the PV string input voltage consistent with the value displayed on the LCD.</li> <li>2. Check whether the PV string voltage meets the maximum input voltage requirements.</li> </ol>

No.	Fault	Cause	Solutions
9	Over Temperature	<ol style="list-style-type: none"> <li>The inverter is installed in a place with poor ventilation.</li> <li>The ambient temperature is too high.</li> <li>The inverter is working improperly.</li> </ol>	<ol style="list-style-type: none"> <li>Check the installation environment and space of the inverter. Make sure that the ventilation meets heat dissipation requirements.</li> <li>Make sure that the fans are working properly and not covered or blocked.</li> <li>Check whether the operating ambient temperature is too high.</li> </ol>
10	AFan Fail	A fault occurs in all fans of the inverter.	<ol style="list-style-type: none"> <li>Restart the inverter and check whether the inverter can work normally.</li> <li>Make sure that the fans are working properly and not covered or blocked.</li> </ol>
11	EFan Fail	A fault occurs on the external fan of the inverter.	
12	IFan Fail	A fault occurs in the internal fan of the inverter.	<ol style="list-style-type: none"> <li>Restart the inverter and check whether the inverter can work normally.</li> <li>A fault occurs in the internal fan, contact after-sales service.</li> </ol>
13	ARC Fault	The PV string cables arc or are in poor contact.	<ol style="list-style-type: none"> <li>Check whether the PV terminals and cables are connected properly.</li> <li>Clear the error messages. Contact after-sales service if the fault occurs frequently.</li> </ol>
14	DC Bus High	Inverter internal fault.	<ol style="list-style-type: none"> <li>Make sure that the software version is the latest one.</li> <li>Restart the inverter to check whether the inverter can work properly.</li> </ol>
15	SPI Fail		
16	Ref 1.5V Fail		
17	AC HCT Fail		
18	GFCI Fail		
19	Relay Check Fail		
20	EEPROM R/W Fail		



## 9.5 Routine Maintenance

Maintaining Item	Maintaining Method	Maintaining Period
System Clean	Check the heat sink, air intake, and air outlet for foreign matter or dust.	Once 6-12 months
Fan	Check the fan for proper working status, low noise, and intact appearance.	Once a year
DC Switch	Turn the DC switch on and off ten consecutive times to make sure that it is working properly.	Once a year
Electrical Connection	Check whether the cables are securely connected. Check whether the cables are broken, or whether there is any exposed copper core.	Once 6-12 months
Sealing	Check whether all the terminals and ports are properly sealed. Reseal the cable hole if it is not sealed or too big.	Once a year
THDi Test	<p>For Australia requirements, in the THDi test, there should add Zref between inverter and mains.</p> <p>Zref:                      Zmax or Zref (phase current&gt;16A)                      Zref: L: <math>0.24 \Omega + j0.15 \Omega</math>; N: <math>0.16 \Omega + j0.10 \Omega</math> (phase current&gt;16A, &lt;21.7A)                      Zref: L: <math>0.15 \Omega + j0.15 \Omega</math>; N: <math>0.1 \Omega + j0.1 \Omega</math> (phase current&gt;21.7A, &lt;75A)                      Zref: <math>\geq 5\% Un/ Irated + j5\% Un/ Irated</math> (phase current&gt;75A)</p>	As needed

## 10 Technical Parameters

Technical Data	GW4K-DT	GW5K-DT	GW6K-DT	GW8K-DT
<b>Input</b>				
Max.Input Power (W)	6000	7500	9000	12000
Max.Input Voltage(V)	1000	1000	1000	1000
MPPT Operating Voltage Range (V)	180~850	180~850	180~850	180~850
MPPT Voltage Range at Nominal Power (V)	410~800	410~800	410~800	410~800
Start-up Voltage (V)	160			
Nominal Input Voltage (V)	620	620	620	620
Max. Input Current per MPPT (A)	12.5			
Max. Short Circuit Current per MPPT (A)	15.6			
Max.Backfeed Current to The Array(A)	0	0	0	0
Number of MPP trackers	2	2	2	2
Number of Strings per MPPT	1	1	1	1
<b>Output</b>				
Nominal Output Power (W)	4000	5000	6000	8000
Nominal Output Apparent Power (VA)	4000	5000	6000	8000
Max. AC Active Power (W) <sup>*1</sup>	4400	5500	6600	8800
Max. AC Apparent Power (VA) <sup>*2</sup>	4400	5500	6600	8800
Nominal Power at 40°C(W) (Only for Brazil)	4000	5000	6000	8000
Max Power at 40°C (including AC overload) (W) (Only for Brazil)	4000	5000	6000	8000
Nominal Output Voltage (V)	400, 3L/N/PE			
Output Voltage Range (V)	180~270 (According to local standard)			
Nominal AC Grid Frequency (Hz)	50 / 60	50 / 60	50 / 60	50/60
AC Grid Frequency Range (Hz)	45~55 / 55-65			
Max. Output Current (A)	6.4	8.0	9.6	12.8

Max. Output Fault Current (Peak and Duration) (A)(at 5ms)	22			
Inrush Current (Peak and Duration) (A)(at 50 $\mu$ s)	10			
Nominal Output Current (A)	5.8	7.2	8.7	11.6
Output Power Factor	~1 (Adjustable from 0.8 leading to 0.8 lagging)			
Max. Total Harmonic Distortion	<3%			
Maximum output overcurrent protection(A)	22.1	22.1	22.1	38.4
<b>Efficiency</b>				
Max. Efficiency	98.2%	98.2%	98.2%	98.2%
European Efficiency	97.6%	97.6%	97.6%	97.6%
<b>Protection</b>				
PV Insulation Resistance Detection	Integrated			
Residual Current Monitoring	Integrated			
PV Reverse Polarity Protection	Integrated			
Anti-islanding Protection	Integrated			
AC Overcurrent Protection	Integrated			
AC Short Circuit Protection	Integrated			
AC Overvoltage Protection	Integrated			
DC Switch	Integrated			
DC Surge Protection	Type III			
AC Surge Protection	Type III			
AFCI	Optional			
<b>General Data</b>				
Operating Temperature Range (°C)	-30~+60 (60 °C for outdoor unconditioned with solar effects.)			
Relative Humidity	0~100%			
Max. Operating Altitude (m) <sup>*3</sup>	≤4000			
Cooling Method	Natural Convection			Smart Fan Cooling
Display	LCD, LED(Optional), WLAN+APP			

Communication	RS485, WiFi or LAN(Optional)	
Communication Protocol	Modbus-RTU (SunSpec Compliant)	
Weight (Kg)	15	16
Dimension (W×H×Dmm)	354 × 433 × 147	354 × 433 × 155
Noise Emission (dB)	<34	<50
Topology	Non-isolated	
Night Power Consumption (W)	<1	
Ingress Protection Rating	IP65	
Anti-corrosion Class	C4	
DC Connector	MC4( 4~6mm <sup>2</sup> )	
AC Connector	Plug and play connector	
Environmental Category	4K4H	
Pollution Degree	III	
Overvoltage Category	DC II / AC III	
Protective class	I	
The Decisive Voltage Class (DVC)	PV:C AC:C Com:A	
Active Anti-islanding Method	AFDPF + AQDPF *4	
Country of Manufacture	China	

Technical Data	GW10KT-DT	GW12KT-DT	GW15KT-DT	GW17KT-DT
<b>Input</b>				
Max.Input Power (W)	15000	18000	22500	25500
Max.Input Voltage(V)	1000	1000	1000	1100
MPPT Operating Voltage Range (V)	180~850	180~850	180~850	200~950
MPPT Voltage Range at Nominal Power (V)	410~800	500~850	500~850	470~860
Start-up Voltage (V)	160	160	160	180
Nominal Input Voltage (V)	620	620	620	620
Max. Input Current per MPPT (A)	12.5	25/12.5	25/12.5	25
Max. Short Circuit Current per MPPT (A)	15.6	31.2/15.6	31.2/15.6	31.2
Max.Backfeed Current to The Array(A)	0	0	0	0
Number of MPP trackers	2	2	2	2
Number of Strings per MPPT	1	2/1	2/1	2
<b>Output</b>				
Nominal Output Power (W)	10000	12000	15000	17000
Nominal Output Apparent Power (VA)	10000	12000	15000	17000
Max. AC Active Power (W)*1	11000	13200	16500	18700
Max. AC Apparent Power (VA) *2	11000	14000	16500	19000
Nominal Power at 40°C(W) (Only for Brazil)	10000	12000	15000	17000
Max Power at 40°C (including AC overload) (W) (Only for Brazil)	10000	12000	15000	17000
Nominal Output Voltage (V)	400, 3L/N/PE			
Output Voltage Range (V)	180~270(According to local standard)			
Nominal AC Grid Frequency (Hz)	50/60	50/60	50/60	50/60
AC Grid Frequency Range (Hz)	45~55 / 55~65	45~55 / 55~65	45~55 / 55~65	45~55 / 55~65
Max. Output Current (A)	16.0	20.3	24.0	28.8

Max. Output Fault Current (Peak and Duration) (A)(at 5ms)	38	61	61	71
Inrush Current (Peak and Duration) (A)(at 50μ s)	30	30	30	30
Nominal Output Current (A)	14.5	17.3	21.7	24.5
Output Power Factor	~1 (Adjustable from 0.8 leading to 0.8 lagging)			
Max. Total Harmonic Distortion	<3%			
Maximum Output Overcurrent Protection (A)	38.4	61.4	61.4	71.2
<b>Efficiency</b>				
Max. Efficiency	98.3%	98.3%	98.3%	98.4%
European Efficiency	97.7%	97.7%	97.7%	97.7%
<b>Protection</b>				
PV Reverse Polarity Protection	Integrated			
Residual Current Monitoring Unit	Integrated			
Anti-islanding Protection	Integrated			
AC Overcurrent Protection	Integrated			
AC Short Circuit Protection	Integrated			
AC Overvoltage Protection	Integrated			
DC Switch	Integrated			
DC Surge Protection	Type III			Type III(Type II Optional)
AC Surge Protection	Type III			
AFCI	Optional			
<b>General Data</b>				
Operating Temperature Range (°C)	-30~60 (60 °C for outdoor unconditioned with solar effects.)			
Relative Humidity	0~100%			
Max. Operating Altitude (m) <sup>*3</sup>	≤4000			
Cooling Method	Smart Fan Cooling			
Display	LCD, LED(Optional), WLAN+APP			
Communication	RS485, WiFi or LAN(Optional)			

Communication Protocol	Modbus-RTU (SunSpec Compliant)			
Weight (Kg)	16	18	18	25
Dimension (W×H×Dmm)	354 × 433 × 155			415 × 511 × 175
Noise Emission (dB)	50			
Topology	Non-isolated			
Night Power Consumption (W)	<1			
Ingress Protection Rating	IP65			
Anti-corrosion Class	C4			
DC Connector	MC4( 4~6mm <sup>2</sup> )			
AC Connector	Plug and play connector			AC Connector
Environmental Category	4K4H			
Pollution Degree	III			
Overtoltage Category	DC II / AC III			
Protective class	Class I			
The Decisive Voltage Class (DVC)	PV:C AC:C Com:A			
Active Anti-islanding Method	AFDPF + AQDPF *4			
Country of Manufacture	China			

Technical Data	GW20KT-DT	GW25KT-DT
<b>Input</b>		
Max.Input Power (W)	30000	37500
Max.Input Voltage(V)	1100	1100
MPPT Operating Voltage Range (V)	200~950	200~950
MPPT Voltage Range at Nominal Power (V)	470~860	510~860
Start-up Voltage (V)	180	180
Nominal Input Voltage (V)	620	620
Max. Input Current per MPPT (A)	25	37.5/25
Max. Short Circuit Current per MPPT (A)	31.2	46.8/31.2
Max.Backfeed Current to The Array(A)	0	0
Number of MPP trackers	2	2
Number of Strings per MPPT	2	3/2
<b>Output</b>		
Nominal Output Power (W)	20000	25000
Nominal Output Apparent Power (VA)	20000	25000
Max. AC Active Power (W)*1	22000	27500
Max. AC Apparent Power (VA) *2	22000	27500
Nominal Power at 40°C(W) (Only for Brazil)	20000	25000
Max Power at 40°C (including AC overload) (W) (Only for Brazil)	20000	25000
Nominal Output Voltage (V)	400, 3L/N/PE	400, 3L/N/PE
Output Voltage Range (V)	180~270(According to local standard)	
Nominal AC Grid Frequency (Hz)	50/60	50/60
AC Grid Frequency Range (Hz)	45~55 / 55~65	45~55 / 55~65
Max. Output Current (A)	31.9	40.8
Max. Output Fault Current (Peak and Duration) (A)(at 5ms)	71	87
Inrush Current (Peak and Duration) (A)(at 50μ s)	50	50



Nominal Output Current (A)	28.9	36.1
Output Power Factor	~1 (Adjustable from 0.8 leading to 0.8 lagging)	
Max. Total Harmonic Distortion	<3%	
Maximum output overcurrent protection(A)	71.2	87
<b>Efficiency</b>		
Max. Efficiency	98.4%	98.4%
European Efficiency	97.7%	97.7%
<b>Protection</b>		
PV Insulation Resistance Detection	Integrated	
Residual Current Monitoring	Integrated	
PV Reverse Polarity Protection	Integrated	
Anti-islanding Protection	Integrated	
AC Overcurrent Protection	Integrated	
AC Short Circuit Protection	Integrated	
AC Overvoltage Protection	Integrated	
DC Switch	Integrated	
DC Surge Protection	Type III(Type II Optional)	
AC Surge Protection	Type III	
AFCI	Optional	
<b>General Data</b>		
Operating Temperature Range (°C)	-30~60 (60 °C for outdoor unconditioned with solar effects.)	
Relative Humidity	0~100%	
Max. Operating Altitude (m) <sup>*3</sup>	≤ 4000	
Cooling Method	Smart Fan Cooling	
Display	LCD, LED(Optional), WLAN+APP	
Communication	RS485, WiFi or LAN(Optional)	
Communication Protocol	Modbus-RTU (SunSpec Compliant)	
Weight (Kg)	25	
Dimension (W×H×Dmm)	415×511×175	
Noise Emission (dB)	50	

Topology	Non-isolated
Night Power Consumption (W)	<1
Ingress Protection Rating	IP65
Anti-corrosion Class	C4
DC Connector	MC4( 4~6mm <sup>2</sup> )
AC Connector	AC Connector
Environmental Category	4K4H
Pollution Degree	III
Overvoltage Category	DC II / AC III
Protective class	Class I
The Decisive Voltage Class (DVC)	PV:C AC:C Com:A
Active Anti-islanding Method	AFDPF + AQDPF *4
Country of Manufacture	China

\*1: For Belgium Max. AC Active Power (W): GW4K-DT is 4000, GW5K-DT is 5000, GW6K-DT is 6000, GW8K-DT is 8000, GW10KT-DT is 10000, GW12KT-DT is 12000, GW15KT-DT is 15000, GW17KT-DT is 17000, GW20KT-DT is 20000, GW25KT-DT is 25000, GW4000-SDT-20 is 4000, GW5000-SDT-20 is 5000, GW6000-SDT-20 is 6000, GW8000-SDT-20 is 8000, GW10K-SDT-20 is 10000, GW12K-SDT-20 is 12000, GW12KLV-SDT-20 is 12000, GW15K-SDT-20 is 15000, GW17K-SDT-20 is 17000, GW20K-SDT-20 is 20000.

\*2: For Belgium Max. Output Apparent Power (VA): GW4K-DT is 4000, GW5K-DT is 5000, GW6K-DT is 6000, GW8K-DT is 8000, GW10KT-DT is 10000, GW12KT-DT is 12000, GW15KT-DT is 15000, GW17KT-DT is 17000, GW20KT-DT is 20000, GW25KT-DT is 25000, GW4000-SDT-20 is 4000, GW5000-SDT-20 is 5000, GW6000-SDT-20 is 6000, GW8000-SDT-20 is 8000, GW10K-SDT-20 is 10000, GW12K-SDT-20 is 12000, GW12KLV-SDT-20 is 12000, GW15K-SDT-20 is 15000, GW17K-SDT-20 is 17000, GW20K-SDT-20 is 20000.

\*3: For Australia Max. Operating Altitude (m) is 3000;

\*4: AFDPF: Active Frequency Drift with Positive Feedback, AQDPF: Active Q Drift with Positive Feedback.

Technical Data	GW8KAU-DT	GW10KAU-DT	GW15KAU-DT	GW20KAU-DT
<b>Input</b>				
Max. Input Power (W)	12000	15000	22500	30000
Max. Input Voltage (V)	1100	1100	1100	1100
MPPT Operating Voltage Range (V)	140~950	140~950	140~950	140~950
MPPT Voltage Range at Nominal Power (V)	180~850	180~850	270~850	360~850
Start-up Voltage (V)	180	180	180	180
Nominal Input Voltage (V)	620	620	620	620
Max. Input Current per MPPT (A)	30	30	30	30
Max. Short Circuit Current per MPPT (A)	37.5	37.5	37.5	37.5
Max. Backfeed Current to The Array (A)	0	0	0	0
Number of MPP Trackers	2	2	2	2
Number of Strings per MPPT	2	2	2	2
<b>Output</b>				
Nominal Output Power (W)	8000	10000	15000	20000
Nominal Output Apparent Power (VA)	8000	10000	15000	20000
Max. AC Active Power (W)*1	8800	11000	16500	22000
Max. AC Apparent Power (VA)*2	8800	11000	16500	22000
Nominal Power at 40°C(W) (Only for Brazil)	8000	10000	15000	20000
Max Power at 40°C (including AC overload) (W) (Only for Brazil)	8000	10000	15000	20000
Nominal Output Voltage (V)	400, 3L/N/PE	400, 3L/N/PE	400, 3L/N/PE	400, 3L/N/PE
Output Voltage Range (V)	180~260(According to local standard)			
Nominal AC Grid Frequency (Hz)	50	50	50	50
AC Grid Frequency Range (Hz)	47~52	47~52	47~52	47~52

Max. Output Current (A)	12.8	16	24	31.9
Max. Output Fault Current (Peak and Duration) (A)(at 5ms)	118	118	118	118
Inrush Current (Peak and Duration) (A)(at 50μ s)	65	65	65	65
Nominal Output Current (A)	11.6	14.5	21.7	28.9
Power Factor	~1 (Adjustable from 0.8 leading to 0.8 lagging)			
Max. Total Harmonic Distortion	<3%			
Maximum Output Overcurrent Protection (A)	38.4	38.4	88.9	88.9
<b>Efficiency</b>				
Max. Efficiency	98.4%	98.4%	98.4%	98.4%
European Efficiency	97.5%	97.5%	97.5%	97.5%
<b>Protection</b>				
PV Insulation Resistance Detection	Integrated			
Residual Current Monitoring	Integrated			
PV Reverse Polarity Protection	Integrated			
Anti-islanding Protection	Integrated			
AC Overcurrent Protection	Integrated			
AC Short Circuit Protection	Integrated			
AC Overvoltage Protection	Integrated			
DC Switch	Integrated			
DC Surge Protection	Type II			
AC Surge Protection	Type III			
AFCI	Optional			
Emergency Power Off	Optional			
Remote Shutdown	Optional			
<b>General Data</b>				
Operating Temperature Range (°C)	-30~+60 (60 °C for outdoor unconditioned with solar effects.)			
Relative Humidity	0~100%			

Max. Operating Altitude (m)	3000			
Cooling Method	Natural Convection		Smart Fan Cooling	
User Interface	LCD, LED(Optional), WLAN+APP			
Communication	RS485, WiFi or LAN(Optional)			
Communication Protocols	Modbus-RTU (SunSpec Compliant)			
Weight (kg)	20.5	20.5	26.0	26.0
Dimension (W×H×D mm)	415 × 511 × 175			
Noise Emission (dB)	<25		<50	
Topology	Non-isolated			
Self-consumption at Night (W)	<1			
Ingress Protection Rating	IP65			
Anti-corrosion Class	C4			
DC Connector	MC4 (4~6mm <sup>2</sup> )			
AC Connector	AC Connector			
Environmental Category	4K4H			
Pollution Degree	III			
Overvoltage Category	DC II / AC III			
Protective Class	Class I			
The Decisive Voltage Class (DVC)	PV:C AC:C Com:A			
Active Anti-islanding Method	AFDPF + AQDPF *3			
Country of Manufacture	China			

\*1: For Belgium Max. AC Active Power (W): GW4K-DT is 4000, GW5K-DT is 5000, GW6K-DT is 6000, GW8K-DT is 8000, GW10KT-DT is 10000, GW12KT-DT is 12000, GW15KT-DT is 15000, GW17KT-DT is 17000, GW20KT-DT is 20000, GW25KT-DT is 25000, GW4000-SDT-20 is 4000, GW5000-SDT-20 is 5000, GW6000-SDT-20 is 6000, GW8000-SDT-20 is 8000, GW10K-SDT-20 is 10000, GW12K-SDT-20 is 12000, GW12KLV-SDT-20 is 12000, GW15K-SDT-20 is 15000, GW17K-SDT-20 is 17000, GW20K-SDT-20 is 20000.

\*2: For Belgium Max. Output Apparent Power (VA): GW4K-DT is 4000, GW5K-DT is 5000, GW6K-DT is 6000, GW8K-DT is 8000, GW10KT-DT is 10000, GW12KT-DT is 12000, GW15KT-DT is 15000, GW17KT-DT is 17000, GW20KT-DT is 20000, GW25KT-DT is 25000, GW4000-SDT-20 is 4000, GW5000-SDT-20 is 5000, GW6000-SDT-20 is 6000, GW8000-SDT-20 is 8000, GW10K-SDT-20 is 10000, GW12K-SDT-20 is 12000, GW12KLV-SDT-20 is 12000, GW15K-SDT-20 is 15000, GW17K-SDT-20 is 17000, GW20K-SDT-20 is 20000.

\*3: AFDPF: Active Frequency Drift with Positive Feedback, AQDPF: Active Q Drift with Positive Feedback.

Technical Data	GW8000-SDT-20	GW10K-SDT-20	GW12K-SDT-20	GW12KLV-SDT-20
<b>Input</b>				
Max.Input Power (W)	16000	20000	24000	19200
Max.Input Voltage(V)	1100	1100	1100	800
MPPT Operating Voltage Range (V)	140~950	140~950	140~950	140-650
MPPT Voltage Range at Nominal Power (V)	290~850	360~850	220~850	360-650
Start-up Voltage (V)	180	180	180	180
Nominal Input Voltage (V)	620	620	620	370
Max. Input Current per MPPT (A)	15	15	30	30
Max. Short Circuit Current per MPPT (A)	18.7	18.7	37.5	37.5
Max.Backfeed Current to The Array(A)	0	0	0	0
Number of MPP trackers	2	2	2	2
Number of Strings per MPPT	1	1	2	2
<b>Output</b>				
Nominal Output Power (W)	8000	10000	12000	12000
Nominal Output Apparent Power (VA)	8000	10000	12000	12000
Max. AC Active Power (W)*1	8800	11000	13200	12000
Max. AC Apparent Power (VA)*1	8800	11000	13200	12000
Nominal Power at 40°C(W) (Only for Brazil)	8000	10000	12000	12000
Max Power at 40°C (including AC overload) (W) (Only for Brazil)	8800	11000	13200	12000
Nominal Output Voltage (V)	380/400/415, 3/N/PE			220/127, 3L/N/PE
Output Voltage Range (V) (According to local standard)	180~270			170-240
Nominal AC Grid Frequency (Hz)	50/60	50/60	50/60	60

AC Grid Frequency Range (Hz)	45~55 / 55~65	45~55 / 55~65	45~55 / 55~65	57.5~62
Max. Output Current (A)	12.8	16.0	19.1	31.9
Max. Output Fault Current (Peak and Duration) (A)(at 5ms)	38	38	89	89
Inrush Current (Peak and Duration) (A)(at 50 $\mu$ s)	30	30	30	50
Nominal Output Current (A)	11.6	14.5	17.4	28.9
Output Power Factor	~1 (Adjustable from 0.8 leading to 0.8 lagging)			
Max. Total Harmonic Distortion	<3%			
Maximum Output Overcurrent Protection (A)	38.4	38.4	88.9	88.9
<b>Efficiency</b>				
Max. Efficiency	98.3%	98.3%	98.4%	96.9%
European Efficiency	97.6%	97.6%	97.8%	96.4%
<b>Protection</b>				
PV Insulation Resistance Detection	Integrated			
Residual Current Monitoring	Integrated			
PV Reverse Polarity Protection	Integrated			
Anti-islanding Protection	Integrated			
AC Overcurrent Protection	Integrated			
AC Short Circuit Protection	Integrated			
AC Overvoltage Protection	Integrated			
DC Switch	Integrated			
DC Surge Protection	Type II			
AC Surge Protection	Type II			
AFCI	Optional			
Emergency Power Off	Optional			
Remote Shutdown	Optional			
<b>General Data</b>				
Operating Temperature Range (°C)	-30~+60 (60 °C for outdoor unconditioned with solar effects.)			

Relative Humidity	0~100%			
Max. Operating Altitude (m) <sup>*2</sup>	4000			
Cooling Method	Natural Convection		Smart Fan Cooling	
Display	LED, LCD(Optional, WLAN+APP)			
Communication	RS485, WiFi or LAN or 4G(Optional)			
Weight (Kg)	20.5	20.5	23.5	26
Dimension (W×H×Dmm)	415 × 511 × 175		415 × 511 × 198	
Noise Emission (dB)	<25		<50	
Topology	Non-isolated			
Night Power Consumption (W)	<1			
Ingress Protection Rating	IP65			
Anti-corrosion Class	C4			
DC Connector	MC4 (4~6mm <sup>2</sup> )			
AC Connector	OT Terminal			
Environmental Category	4K4H			
Pollution Degree	III			
Overvoltage Category	DC II / AC III			
Protective class	I			
The Decisive Voltage Class (DVC)	PV: C AC: C Com: A			
Active Anti-islanding Method	AFDPF + AQDPF <sup>*3</sup>			
Country of Manufacture	China			



Technical Data	GW15K-SDT-20	GW17K-SDT-20	GW20K-SDT-20
<b>Input</b>			
Max.Input Power (W)	30000	34000	40000
Max.Input Voltage(V)	1100	1100	1100
MPPT Operating Voltage Range (V)	140~950	140~950	140~950
MPPT Voltage Range at Nominal Power (V)	275~850	300~850	360~850
Start-up Voltage (V)	180	180	180
Nominal Input Voltage (V)	620	620	620
Max. Input Current per MPPT (A)	30	30	30
Max. Short Circuit Current per MPPT (A)	37.5	37.5	37.5
Max.Backfeed Current to The Array(A)	0	0	0
Number of MPP trackers	2	2	2
Number of Strings per MPPT	2	2	2
<b>Output</b>			
Nominal Output Power (W)	15000	17000	20000
Nominal Output Apparent Power (VA)	15000	17000	20000
Max. AC Active Power (W)*1	16500	18700	22000
Max. AC Apparent Power (VA) *1	16500	18700	22000
Nominal Power at 40°C(W) (Only for Brazil)	15000	17000	20000
Max Power at 40°C (including AC overload) (W) (Only for Brazil)	16500	18700	22000
Nominal Output Voltage (V)	380/400/415, 3/N/PE		
Output Voltage Range (V)(According to local standard)	180~270		
Nominal AC Grid Frequency (Hz)	50/60	50/60	50/60
AC Grid Frequency Range (Hz)	45~55 / 55~65	45~55 / 55~65	45~55 / 55~65
Max. Output Current (A)	24.0	27.1	32.0
Max. Output Fault Current (Peak and Duration) (A)(at 5ms)	89	89	89
Inrush Current (Peak and Duration) (A) (at 50μ s)	50	50	50

Nominal Output Current (A)	21.7	24.6	29.0
Output Power Factor	~1 (Adjustable from 0.8 leading to 0.8 lagging)		
Max. Total Harmonic Distortion	<3%		
Maximum Output Overcurrent Protection (A)	88.9		
<b>Efficiency</b>			
Max. Efficiency	98.4%	98.4%	98.4%
European Efficiency	97.8%	97.8%	97.8%
<b>Protection</b>			
PV Insulation Resistance Detection	Integrated		
Residual Current Monitoring	Integrated		
PV Reverse Polarity Protection	Integrated		
Anti-islanding Protection	Integrated		
AC Overcurrent Protection	Integrated		
AC Short Circuit Protection	Integrated		
AC Overvoltage Protection	Integrated		
DC Switch	Integrated		
DC Surge Protection	Type II		
AC Surge Protection	Type II		
AFCI	Optional		
Emergency Power Off	Optional		
Remote Shutdown	Optional		
<b>General Data</b>			
Operating Temperature Range (°C)	-30~+60 (60 °C for outdoor unconditioned with solar effects.)		
Relative Humidity	0~100%		
Max. Operating Altitude (m)*2	4000		
Cooling Method	Smart Fan Cooling		
Display	LED, LCD(Optional, WLAN+APP)		
Communication	RS485, WiFi or LAN or 4G(Optional)		
Weight (Kg)	26		
Dimension (W×H×Dmm)	415 × 511 × 198		

Noise Emission (dB)	<50
Topology	Non-isolated
Night Power Consumption (W)	<1
Ingress Protection Rating	IP65
Anti-corrosion Class	C4
DC Connector	MC4 (4~6mm <sup>2</sup> )
AC Connector	OT Terminal
Environmental Category	4K4H
Pollution Degree	III
Overvoltage Category	DC II / AC III
Protective class	I
The Decisive Voltage Class (DVC)	PV: C AC: C Com: A
Active Anti-islanding Method	AFDPF + AQDPF * <sup>3</sup>
Country of Manufacture	China

\*1. For Chile Max. AC Active Power (W) & Max. Output Apparent Power (VA): GW4000-SDT-20 is 4000, GW5000-SDT-20 is 5000, GW6000-SDT-20 is 6000, GW8000-SDT-20 is 8000, GW10K-SDT-20 is 10000, GW12K-SDT-20 is 12000, GW12KLV-SDT-20 is 12000, GW15K-SDT-20 is 15000, GW17K-SDT-20 is 17000, GW20K-SDT-20 is 20000.

\*2. For Australia, Max. Operating Altitude (m) is 3000.

\*3. AFDPF: Active Frequency Drift with Positive Feedback, AQDPF: Active Q Drift with Positive Feedback.

Technical Data	GW4000-SDT-20	GW5000-SDT-20	GW6000-SDT-20
<b>Input</b>			
Max.Input Power (W)	6000	7500	9000
Max.Input Voltage(V)	1000	1000	1000
MPPT Operating Voltage Range (V)	180~850	180~850	180~850
MPPT Voltage Range at Nominal Power (V)	410~800	410~800	410~800
Start-up Voltage (V)	180		
Nominal Input Voltage (V)	620	620	620
Max. Input Current per MPPT (A)	16		
Max. Short Circuit Current per MPPT (A)	20		
Max.Backfeed Current to The Array(A)	0	0	0
Number of MPP trackers	2	2	2
Number of Strings per MPPT	1	1	1
<b>Output</b>			
Nominal Output Power (W)	4000	5000	6000
Nominal Output Apparent Power (VA)	4000	5000	6000
Max. AC Active Power (W)*1	4400	5500	6600
Max. AC Apparent Power (VA)*1	4400	5500	6600
Nominal Power at 40°C(W) (Only for Brazil)	4,000	5,000	6,000
Max Power at 40°C (including AC overload) (W) (Only for Brazil)	4,400	5,500	6,600
Nominal Output Voltage (V)	400, 3L/N/PE		
Output Voltage Range (V)	180~270		
Nominal AC Grid Frequency (Hz)	50 / 60	50 / 60	50 / 60
AC Grid Frequency Range (Hz)	45-55 / 55-65		
Max. Output Current (A)	6.4	8.0	9.6

Max. Output Fault Current (Peak and Duration) (A)(at 5ms)	22	22	22
Inrush Current (Peak and Duration) (A)(at 50 $\mu$ s)	10	10	10
Nominal Output Current (A)	5.8	7.2	8.7
Output Power Factor	~1 (Adjustable from 0.8 leading to 0.8 lagging)		
Max. Total Harmonic Distortion	<3%		
Maximum Output Overcurrent Protection (A)	22	22	22
<b>Efficiency</b>			
Max. Efficiency	98.2%	98.2%	98.2%
European Efficiency	97.6%	97.6%	97.6%
<b>Protection</b>			
PV Insulation Resistance Detection	Integrated		
Residual Current Monitoring	Integrated		
PV Reverse Polarity Protection	Integrated		
Anti-islanding Protection	Integrated		
AC Overcurrent Protection	Integrated		
AC Short Circuit Protection	Integrated		
AC Overvoltage Protection	Integrated		
DC Switch	Integrated		
DC Surge Protection	Type III (Type II Optional)		
AC Surge Protection	Type III		
AFCI	Optional		
Emergency Power Off	Optional		
Remote Shutdown	Optional		
<b>General Data</b>			
Operating Temperature Range (°C)	-30~+60 (60 °C for outdoor unconditioned with solar effects.)		
Relative Humidity	0~100%		
Max. Operating Altitude (m) <sup>*2</sup>	4000		
Cooling Method	Natural Convection		

Display	LED, LCD(Optional, WLAN+APP)
Communication	RS485, WiFi or LAN or 4G(Optional)
Weight (Kg)	15
Dimension (W×H×Dmm)	354 × 433 × 147
Noise Emission (dB)	<34
Topology	Non-isolated
Night Power Consumption (W)	<1
Ingress Protection Rating	IP65
Anti-corrosion Class	C4
DC Connector	MC4 (4~6mm <sup>2</sup> )
AC Connector	Plug and play connector
Environmental Category	4K4H
Pollution Degree	III
Overvoltage Category	DC II / AC III
Protective class	Class I
The Decisive Voltage Class (DVC)	PV: C AC: C Com: A
Active Anti-islanding Method	AFDPF + AQDPF <sup>*3</sup>
Country of Manufacture	China

\*1. For Chile Max. AC Active Power (W) & Max. Output Apparent Power (VA): GW4000-SDT-20 is 4000, GW5000-SDT-20 is 5000, GW6000-SDT-20 is 6000, GW8000-SDT-20 is 8000, GW10K-SDT-20 is 10000, GW12K-SDT-20 is 12000, GW12KLV-SDT-20 is 12000, GW15K-SDT-20 is 15000, GW17K-SDT-20 is 17000, GW20K-SDT-20 is 20000.

\*2. For Australia, Max. Operating Altitude (m) is 3000.

\*3. AFDPF: Active Frequency Drift with Positive Feedback, AQDPF: Active Q Drift with Positive Feedback.



GoodWe Website

## **GoodWe Technologies Co., Ltd.**

 No. 90 Zijin Rd., New District, Suzhou, 215011, China

 [www.goodwe.com](http://www.goodwe.com)

 [service@goodwe.com](mailto:service@goodwe.com)



Local Contacts